

RENTAL LED SCREEN

D SERIES

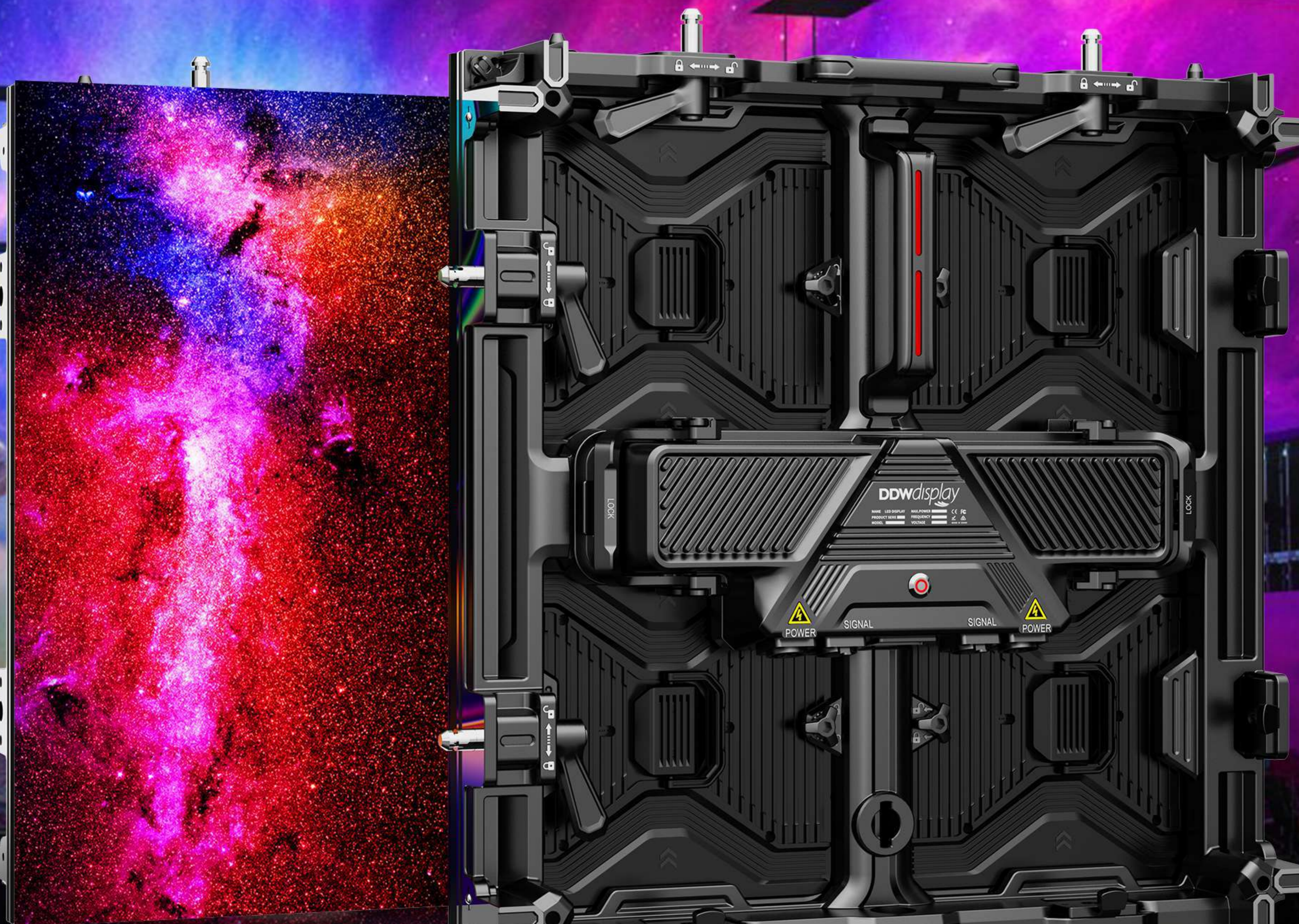

P1.56

P1.95

P2.604

P2.976

P3.91

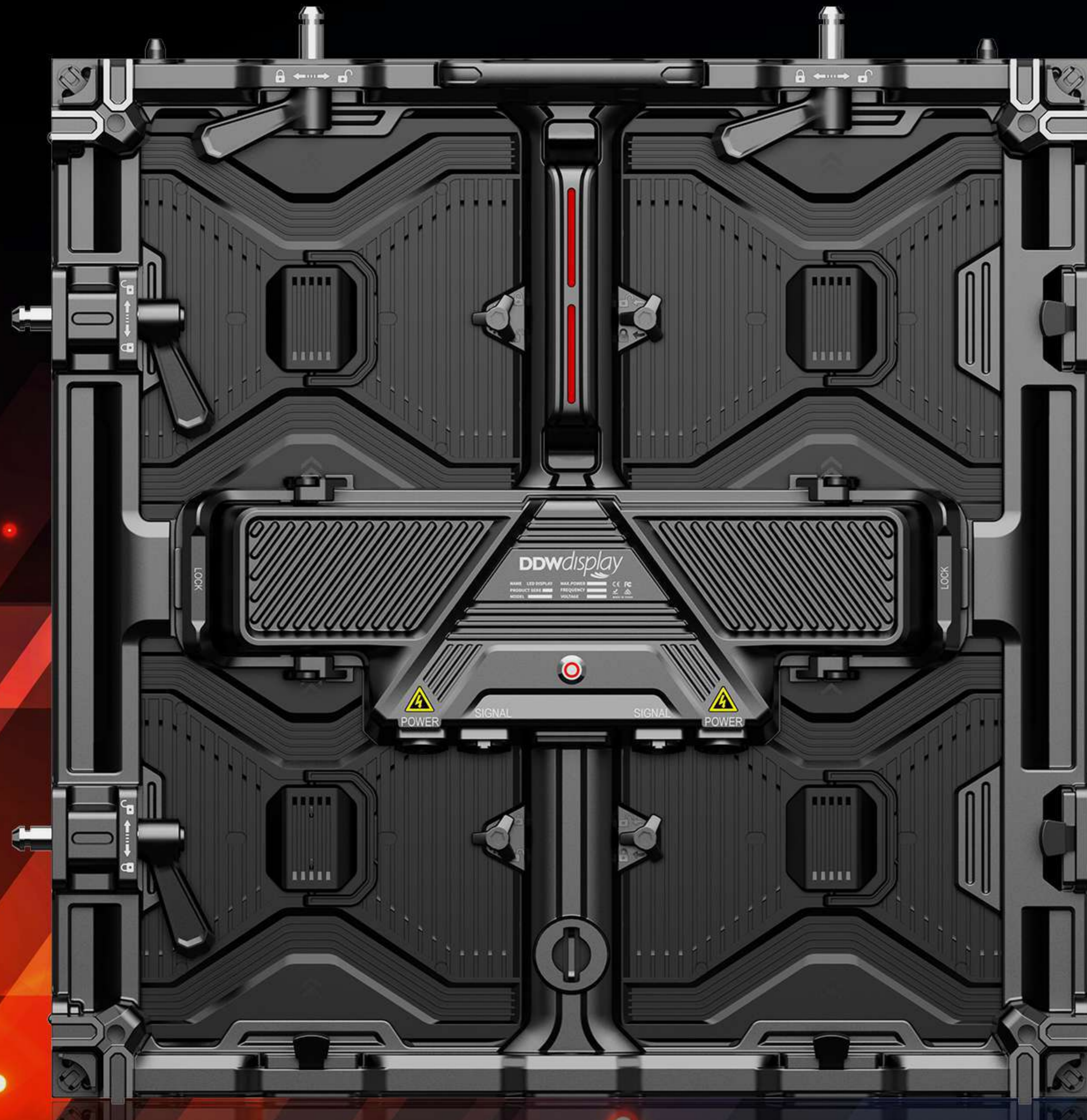

D SERIES

Pixel Pitch: P1.56 P1.95 P2.604 P2.97 P3.91(indoor)
P2.604 P2.976 P3.91(outdoor)

Cabinet size:500*500mm

Module size:250*250mm

Cabinet Weight:8kg(indoor)/8.8(outdoor)kg

Brightness:800-1200cd/m²(indoor) 4500-6000cd/m²(outdoor)

Refresh rate:7680Hz



IP65 waterproof

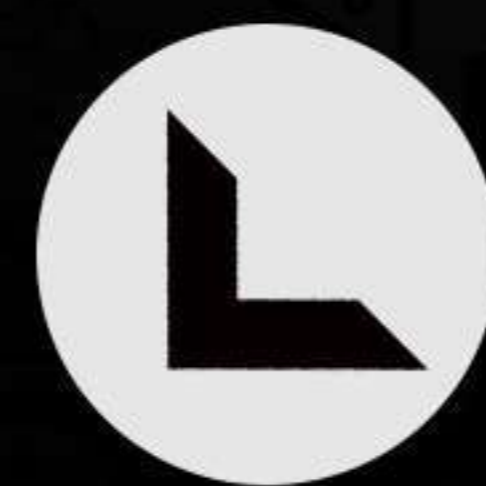

Curved & Right angle available



6000nits high brightness



Front Rear maintenance



High end design



Dual backup signal power supply (Optional)

STANDARD VERSION

Specs \ Applications	INDOOR 500*500(mm)					OUTDOOR 500*500(mm)		
Pixel Pitch	1.56mm	1.95mm	2.604mm	2.97mm	3.91mm	2.604mm	2.976mm	3.91mm
Lamp Types	SMD1212	SMD1515	SMD1515	SMD1515	SMD2121	SMD1415	SMD1415	SMD1921
Scan	1/40S	1/32S	1/32	1/28S	1/16S	1/24S	1/28S	1/16S
Module size(mm)	250*250							
Module Resolution(Pixels/pcs)	160*160	128*128	96*96	84*84	64*64	96*96	84*84	64*64
Module weight(kg)	0.5	0.5	0.5	0.5	0.5	0.7	0.7	0.7
Cabinet size(mm)	500*500							
Cabinet resolution(Pixels/pcs)	320*320	256*256	192*192	168*168	128*128	192*192	168*168	128*128
Cabinet Weight(kg)	8	8	8	8	8	8.8	8.8	8.8
Per cabinet Module quantity(pcs)	4							
Pixel density(Pixels/m ²)	409600	262144	147456	112896	65536	147456	112896	65536
Material	Die-casting aluminum							
Real Brightness(cd/m ²)	800-1000	800-1000	800-1000	800-1000	1000-1200	4500	5000	5000
Grey grade	14bit	14bit	14bit	14bit	14bit	14bit	14bit	14bit
Refresh rate	>=7680Hz CFD455							
Input Voltage	AC100-240V, 50/60Hz							
Power Consumption(Max.W/m ²)	Around 640					Around 640		
Power Consumption(Ave.W/m ²)	Around 300					Around 300		
IP rating(Front/Rear)	IP54					IP65		
Arc angle	-10°、-7.5°、-5°、-2.5°、0°、2.5°、5°、7.5°、10°							
Operating temperature	-20°C ~ +45°C							
Operating humidity	10% ~90%RH							
Storage temperature	-10°C ~ +40°C							
Storage humidity	10% ~60%RH							
Lifespan (Hrs)	≥50,000							

PREMIUM VERSION

Specs \ Applications	INDOOR 500*500(mm)					OUTDOOR 500*500(mm)		
Pixel Pitch	1.56mm	1.95mm	2.604mm	2.97mm	3.91mm	2.604mm	2.976mm	3.91mm
Lamp Types	SMD1212	SMD1515	SMD1515	SMD1515	SMD2121	SMD1415	SMD1415	SMD1921
Scan	1/8S	1/8S	1/16	1/28S	1/16S	1/12S	1/14S	1/16S
Module size(mm)	250*250							
Module Resolution(Pixels/pcs)	160*160	128*128	96*96	84*84	64*64	96*96	84*84	64*64
Module weight(kg)	0.5	0.5	0.5	0.5	0.5	0.7	0.7	0.7
Cabinet size(mm)	500*500							
Cabinet resolution(Pixels/pcs)	320*320	256*256	192*192	168*168	128*128	192*192	168*168	128*128
Cabinet Weight(kg)	8	8	8	8	8	8.8	8.8	8.8
Per cabinet Module quantity(pcs)	4							
Pixel density(Pixels/m ²)	409600	262144	147456	112896	65536	147456	112896	65536
Material	Die-casting aluminum							
Real Brightness(cd/m ²)	1200	1200	1200	1200	1200	6000	5000	5000
Grey grade	16bit	16bit	16bit	16bit	16bit	16bit	16bit	16bit
Refresh rate	7680Hz							
Input Voltage	AC100-240V, 50/60Hz							
Power Consumption(Max.W/m ²)	Around 640					Around 640		
Power Consumption(Ave.W/m ²)	Around 300					Around 300		
IP rating(Front/Rear)	IP54					IP65		
Arc angle	-10°、 -7.5°、 -5°、 -2.5°、 0°、 2.5°、 5°、 7.5°、 10°							
Operating temperature	-20°C ~ +45°C							
Operating humidity	10% ~90%RH							
Storage temperature	-10°C ~ +40°C							
Storage humidity	10% ~60%RH							
Lifespan (Hrs)	≥50,000							

CABINET DIAGRAM

Excellent product came in all details from cabinet handle. cabinet fixed slot, fast lock magnet adsorption module, module installation knob, Power& signal connector detachable power boxing, and more

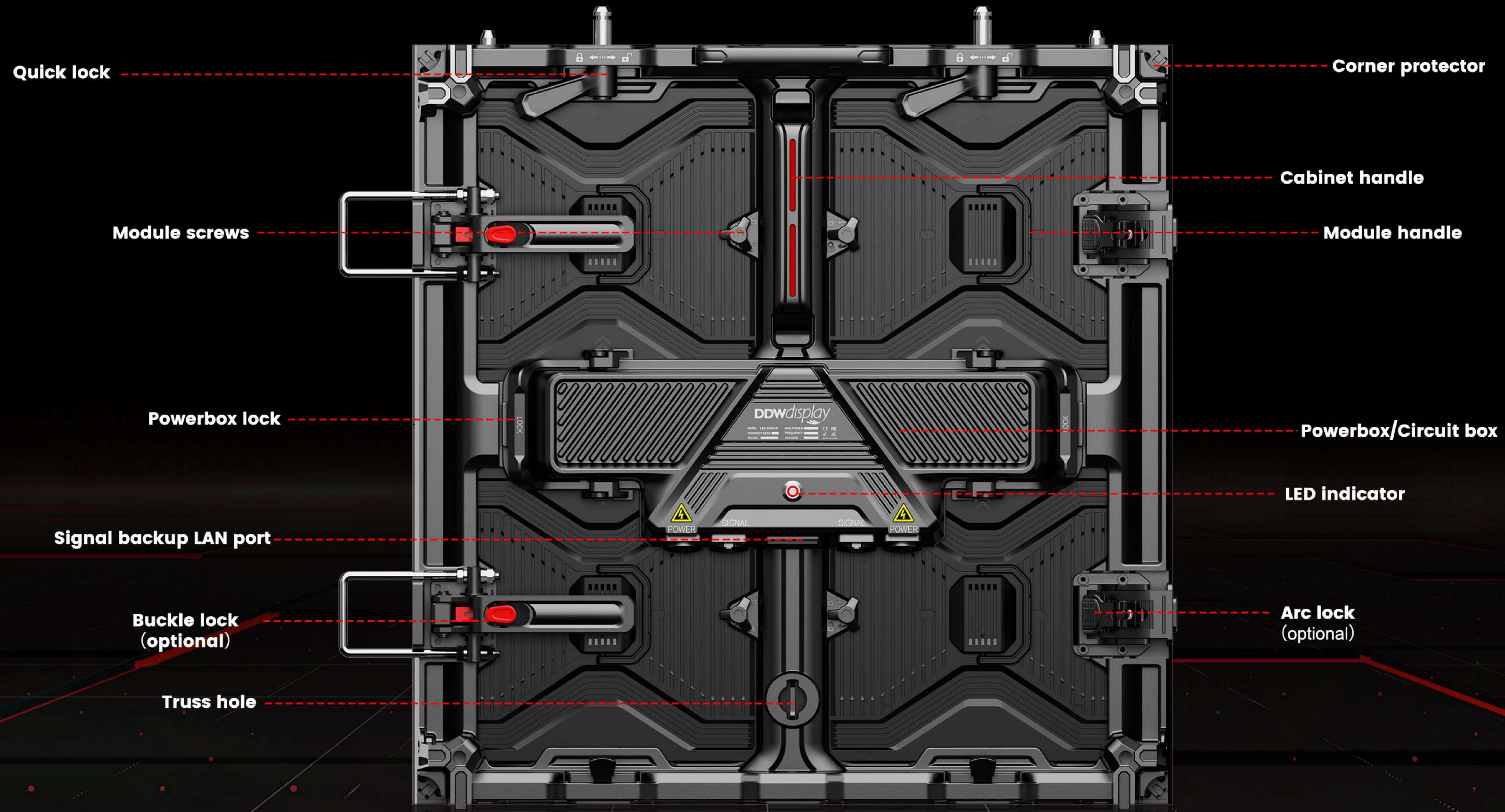

**FAST
SMART
STRONG**

**FLEXIBILITY
EXTENSIBILITY**

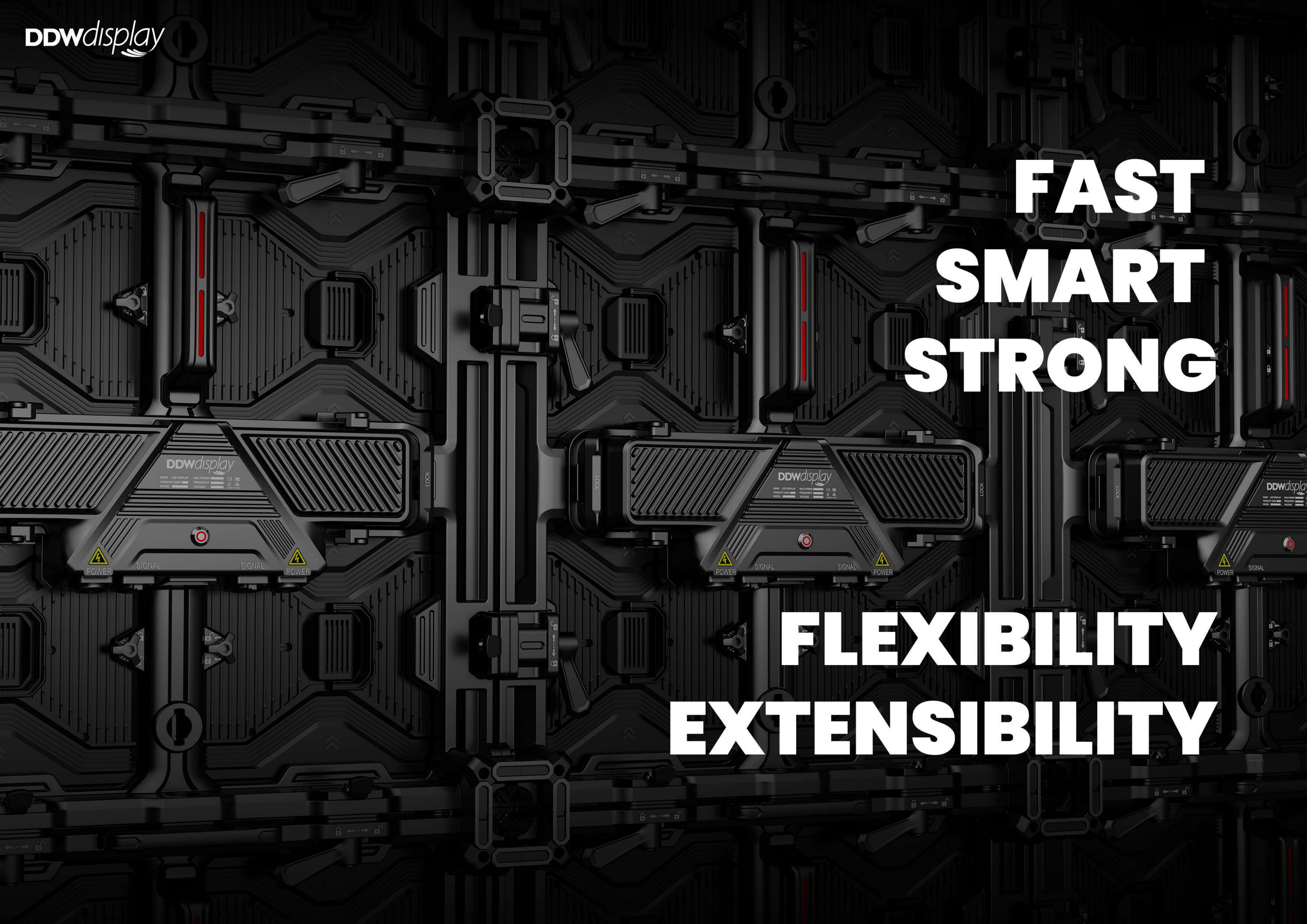

V0 FLAME RETARDANT

Made out of V0 high-proof flame-retardant material, excellent high temperature resistance performance.



Protection Level from high to low in
UL94: V0>V1>V2>V5>HB

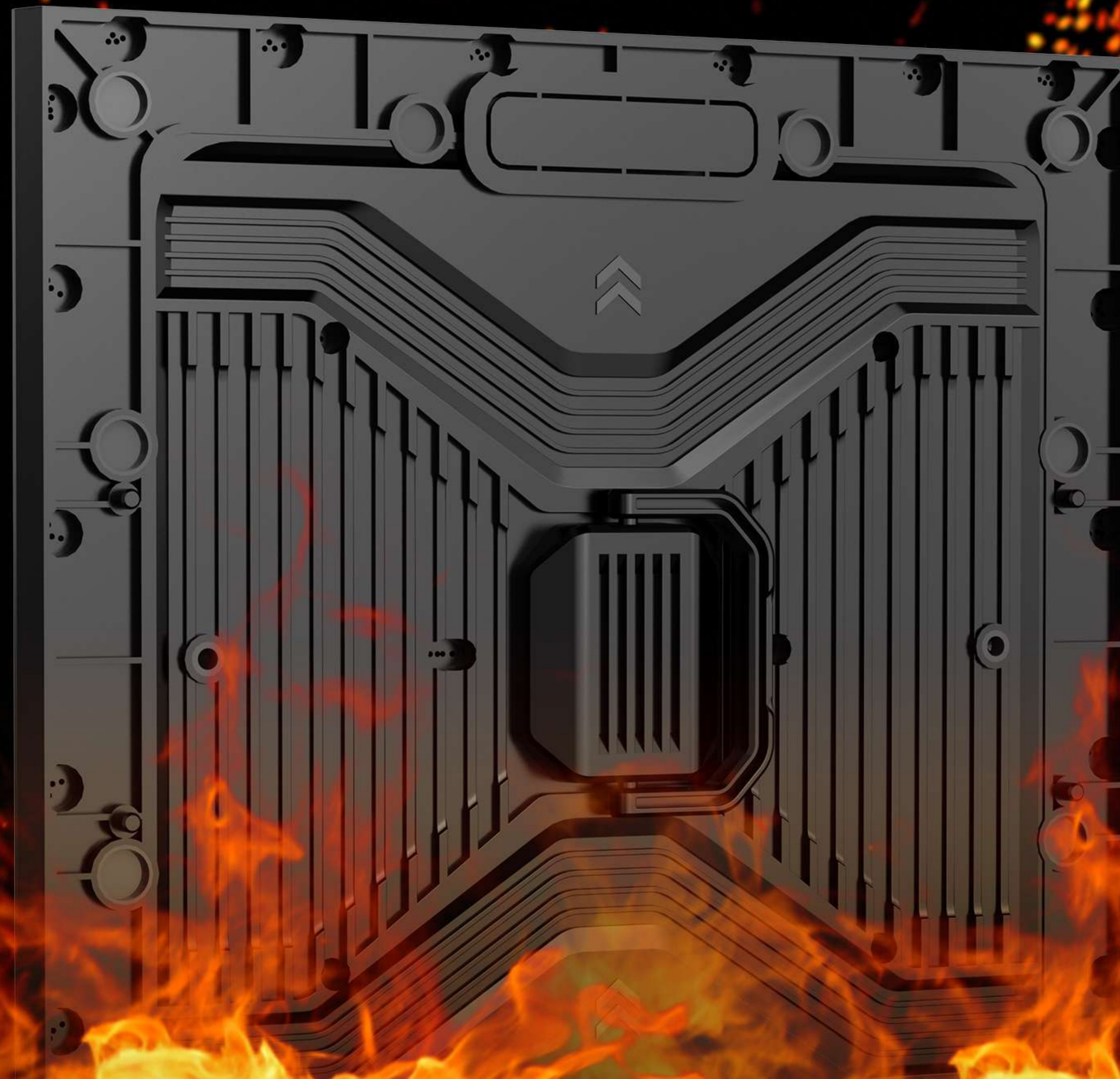

LED MODULE DESIGN

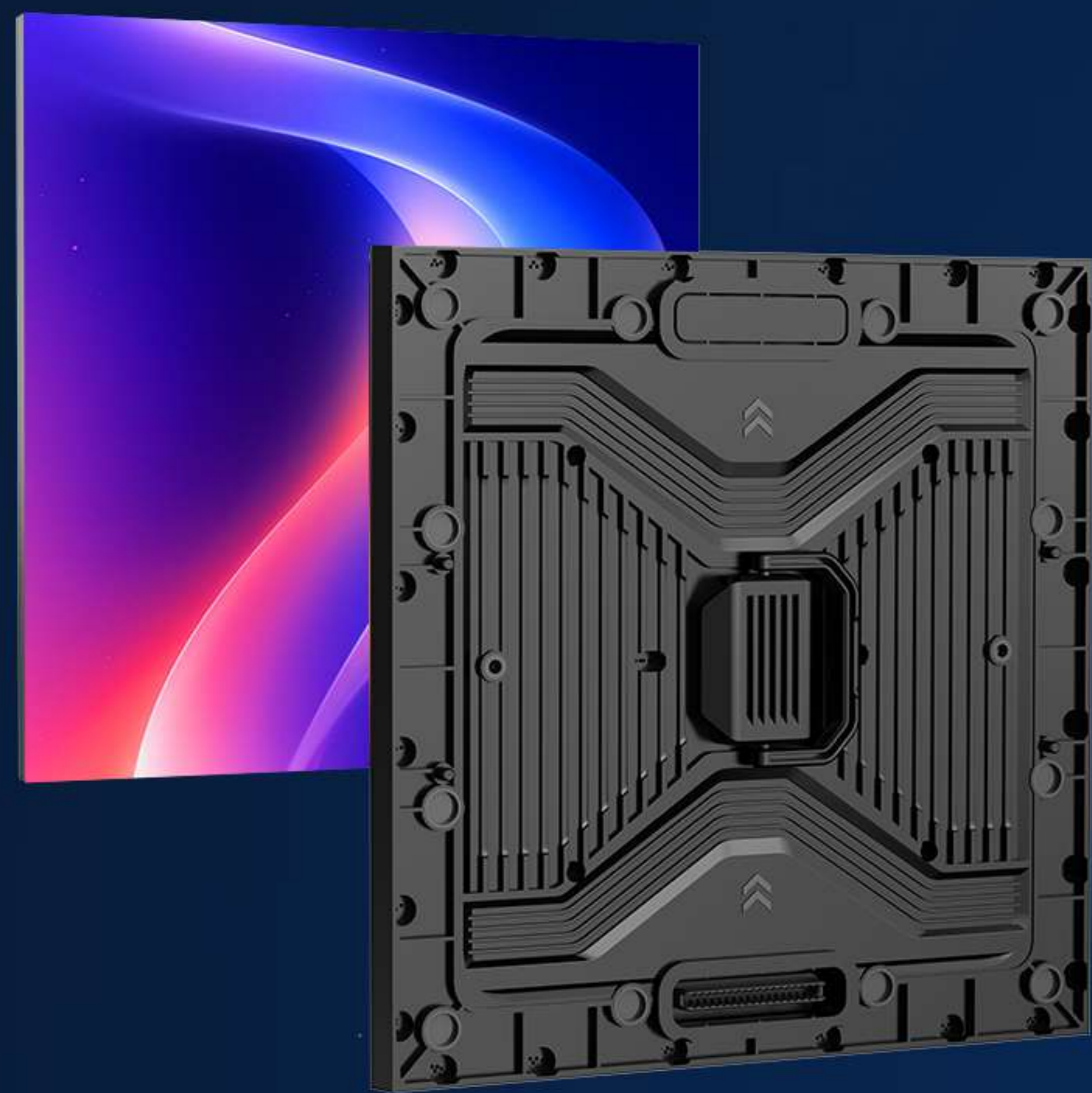

Indoor 250x250mm

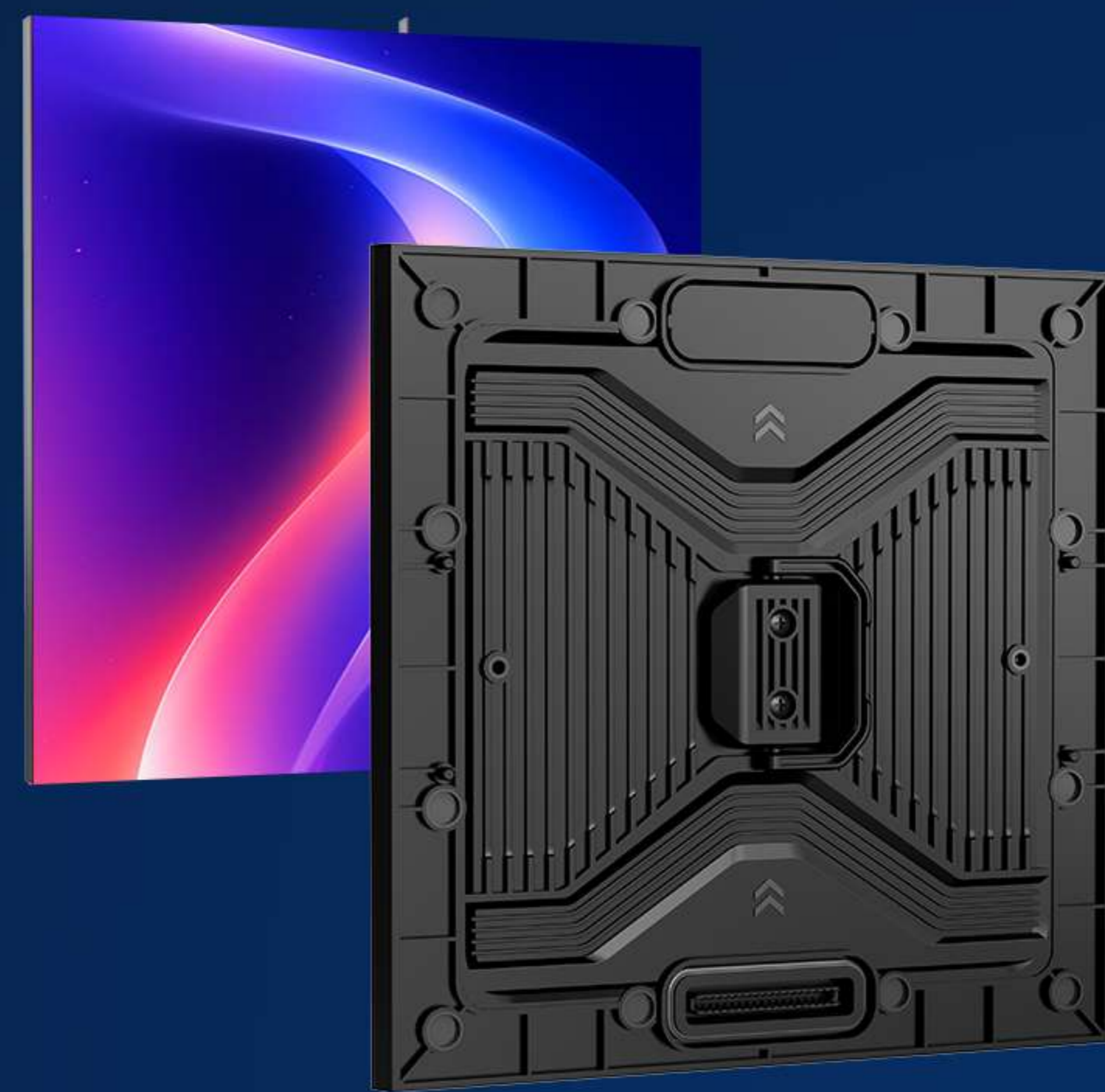

Outdoor 250x250mm

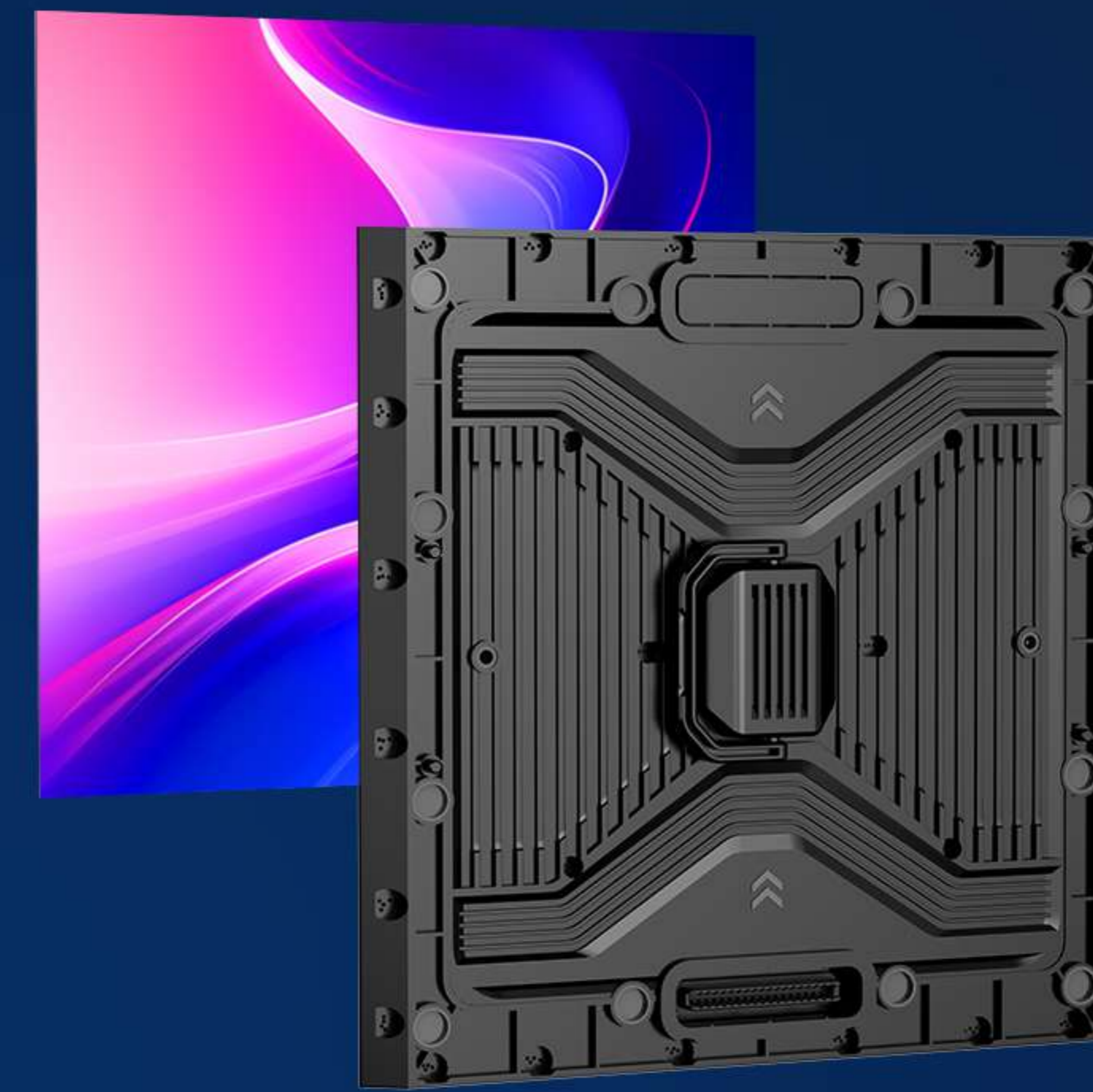

Indoor 45° beveled edge 250x250mm

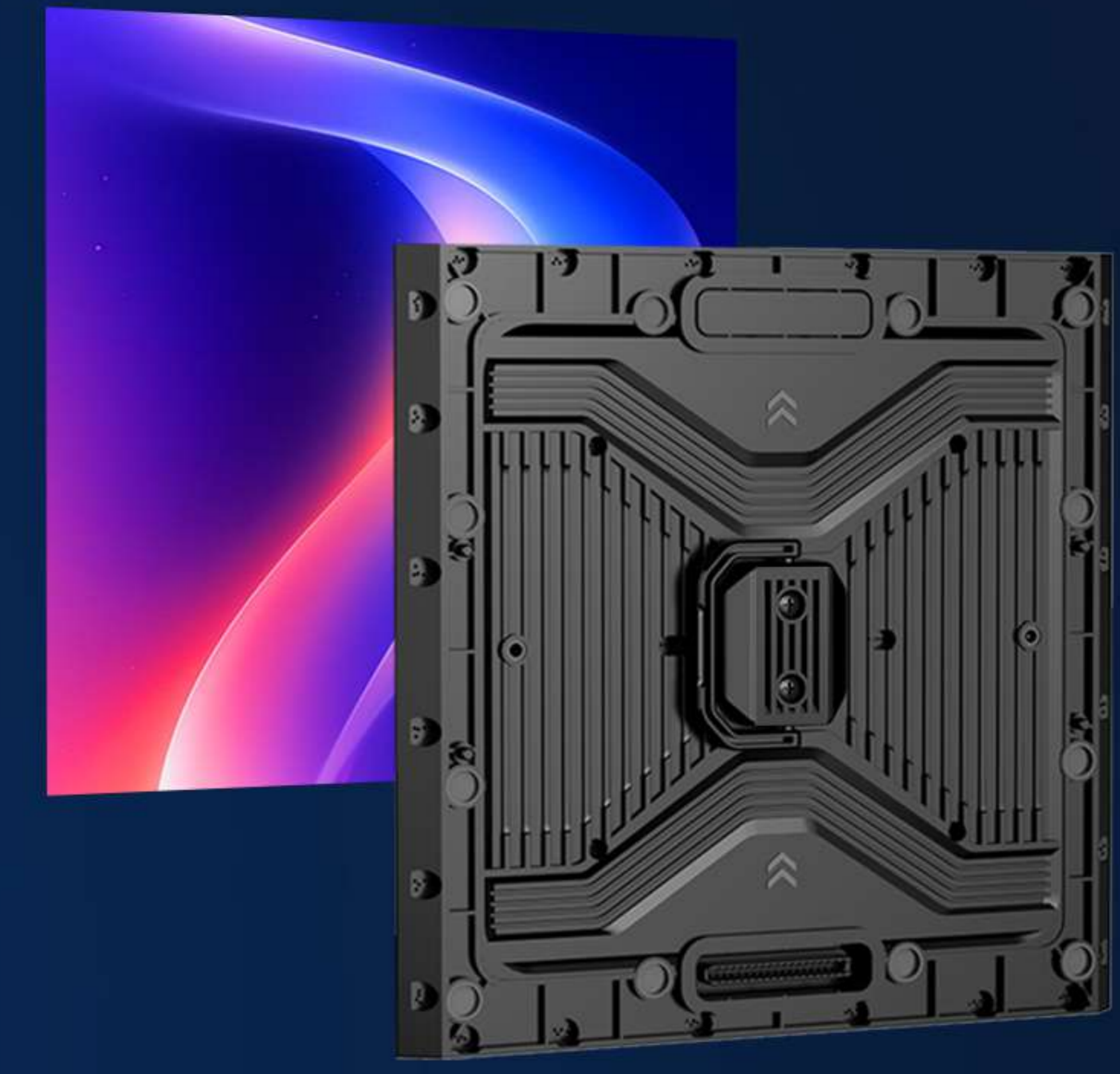

Outdoor 45° beveled edge 250x250mm

CURVED SHAPE

Exclusive customized buckle lock, can help design various curved shapes.

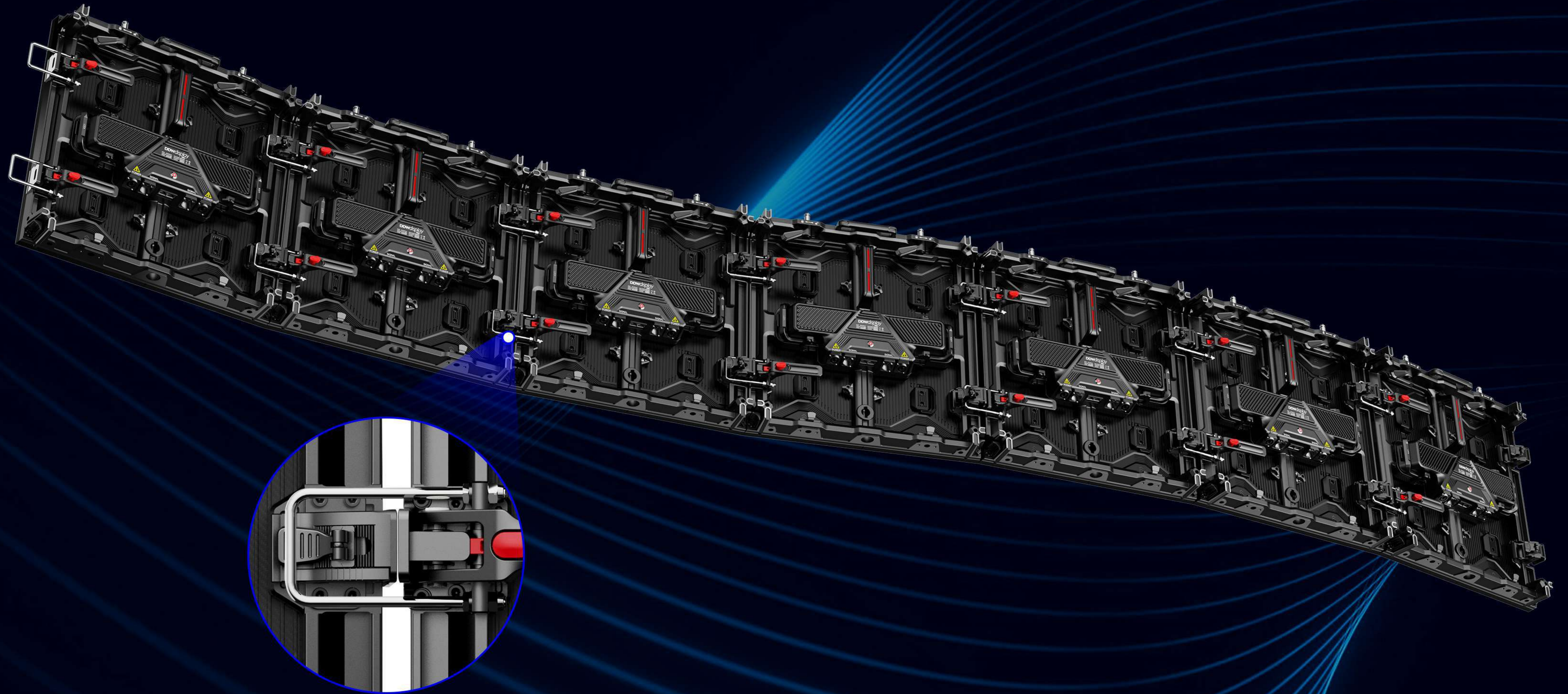

Arc lock adjustment: -10° 、 -7.5° 、 -5° 、 -2.5° 、 0° 、 2.5° 、 5° 、 7.5° 、 10°

FRONT AND REAR MAINTENANCE

Strong magnetic design with handle screws, easy to assemble and disassemble for both indoor and outdoor conditions.

Module screws

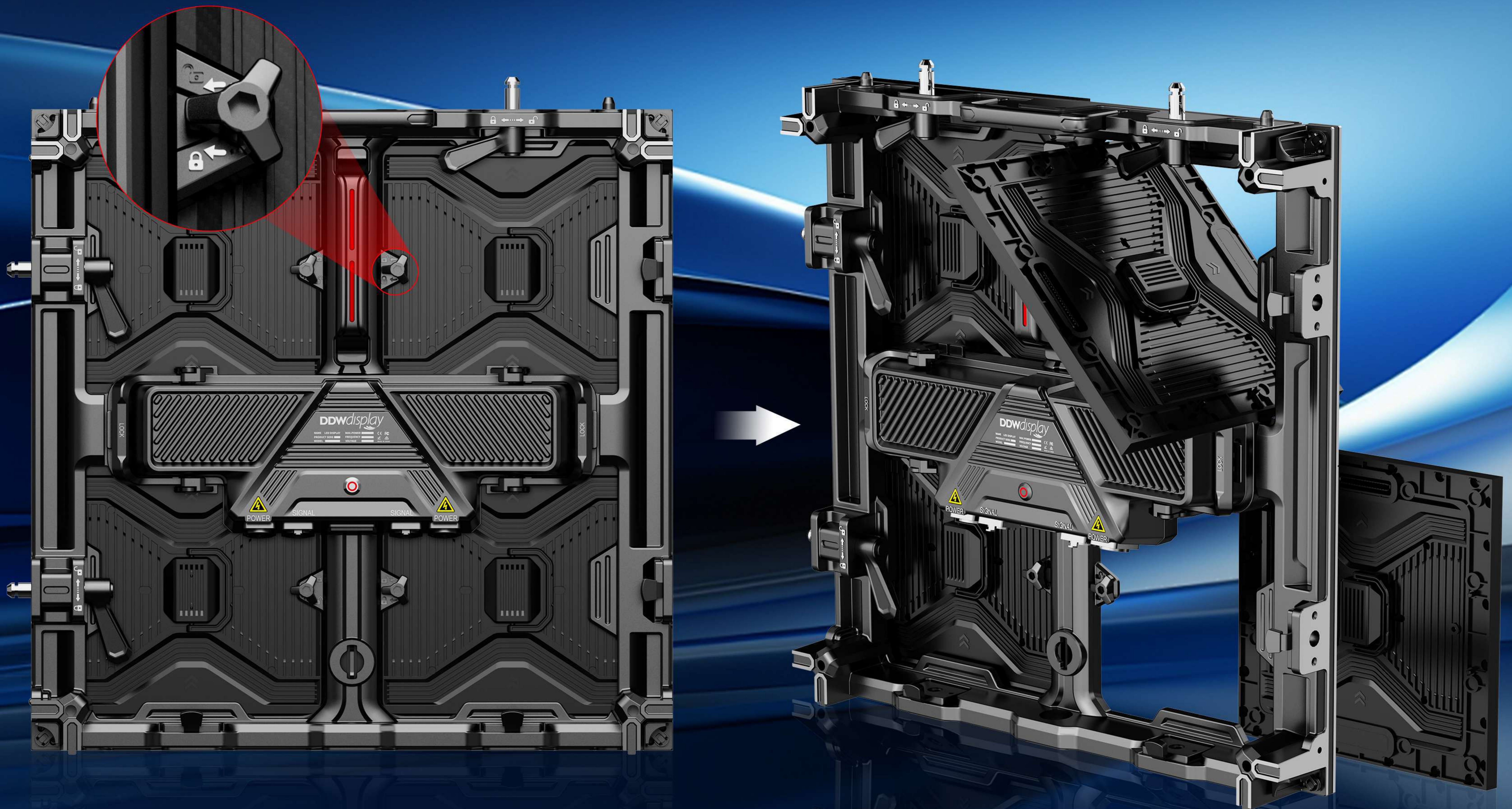

HIGH PRECISION DESIGN

Die cast aluminum sheet metal on both sides strengthens the cabinet, making it less prone to deformation, high precision cabinets design, ultra-high flatness of led screen

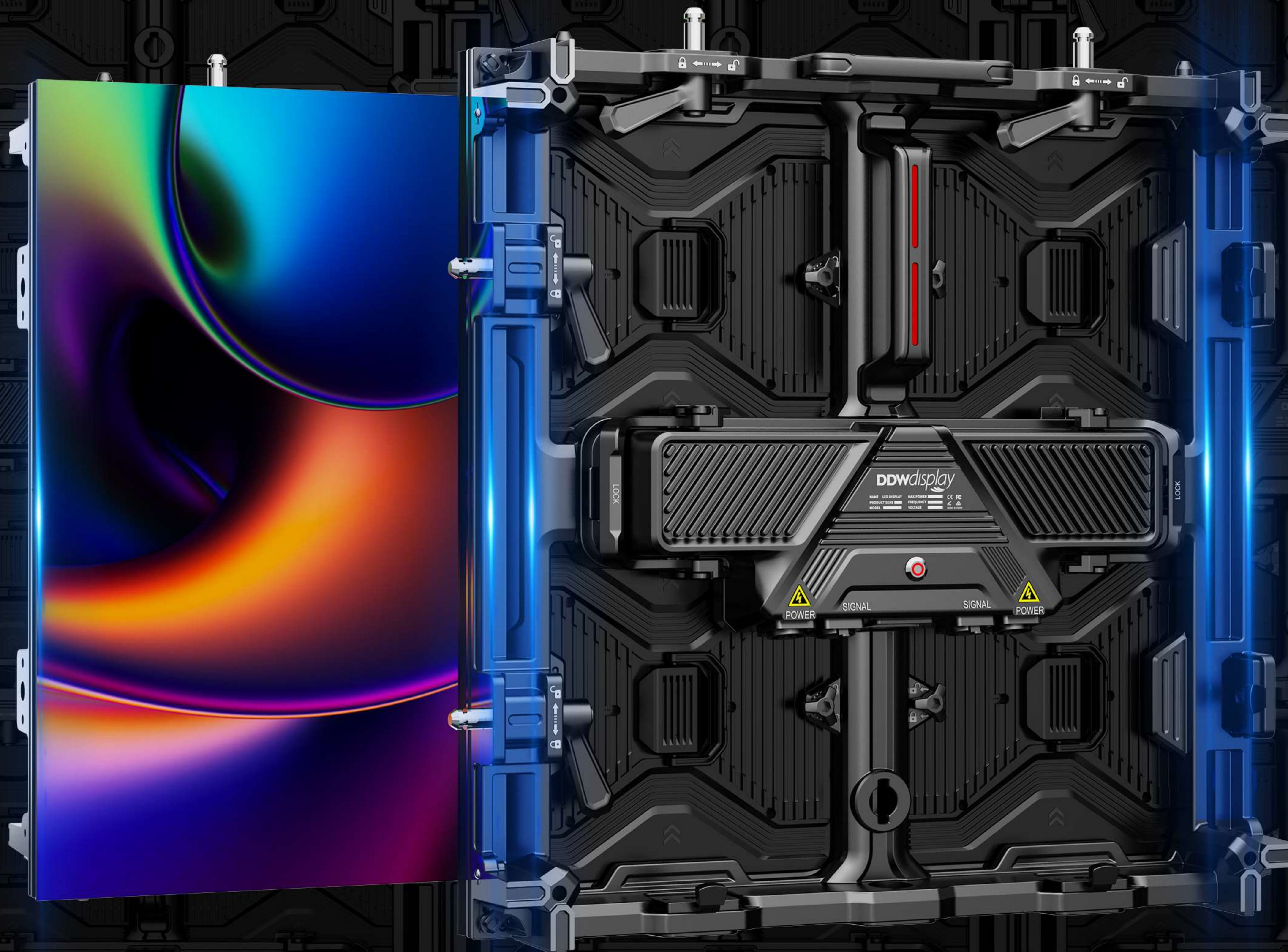

RECEIVING CARD OPTIONAL

Receiving cards can be optional according to different demands.

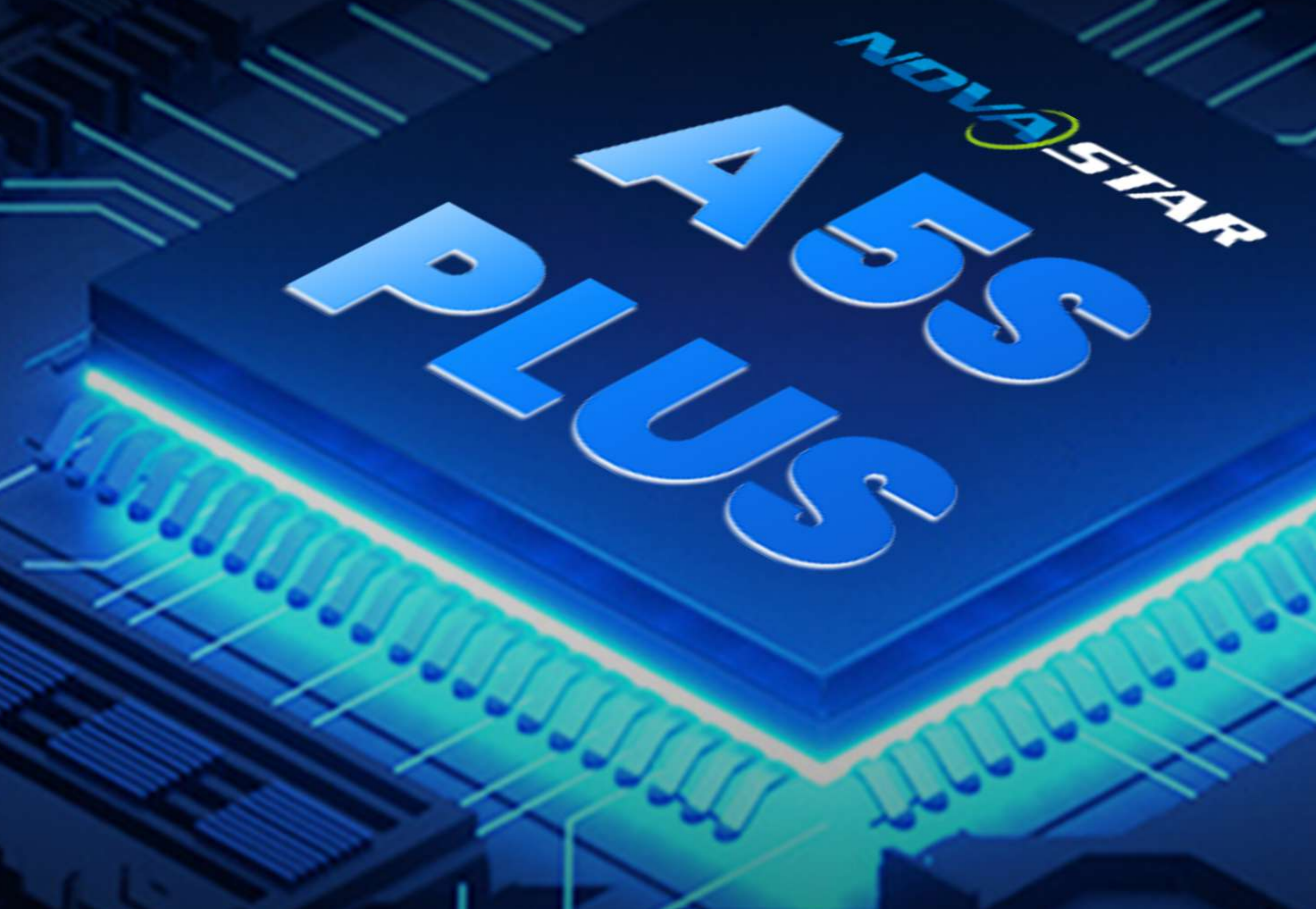

MULTI OPTION LED LAMPS

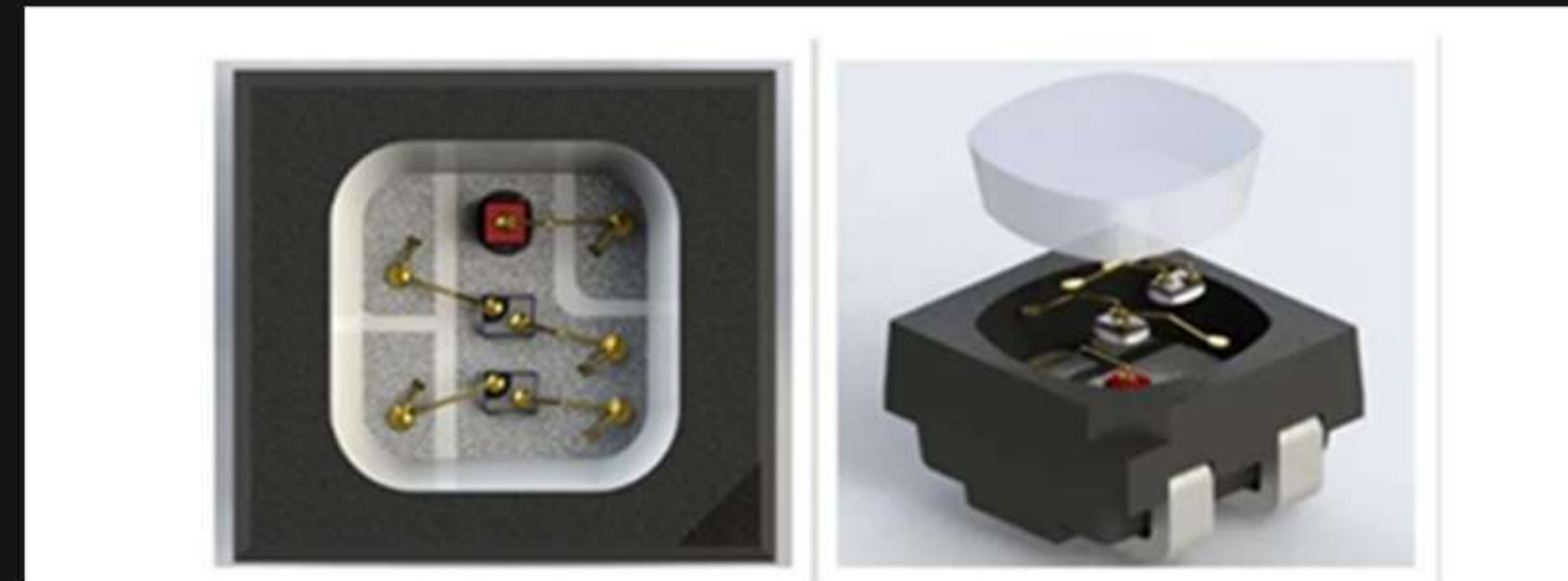

Copper wire copper bracket, long service life, high brightness, good display effect

Adopt high-quality brand LED lamps, can also accept customization according to demands.



HIGH BRIGHTNESS

Indoor brightness up to **1000**cd/m²
outdoor use of gold wire brightness up to **6000**cd/m²

D SERIES

vs

other

Indoor Cabinet: **1000nits**

Low brightness



Outdoor cabinet: **6000nits**

Low brightness



6000 m² nits

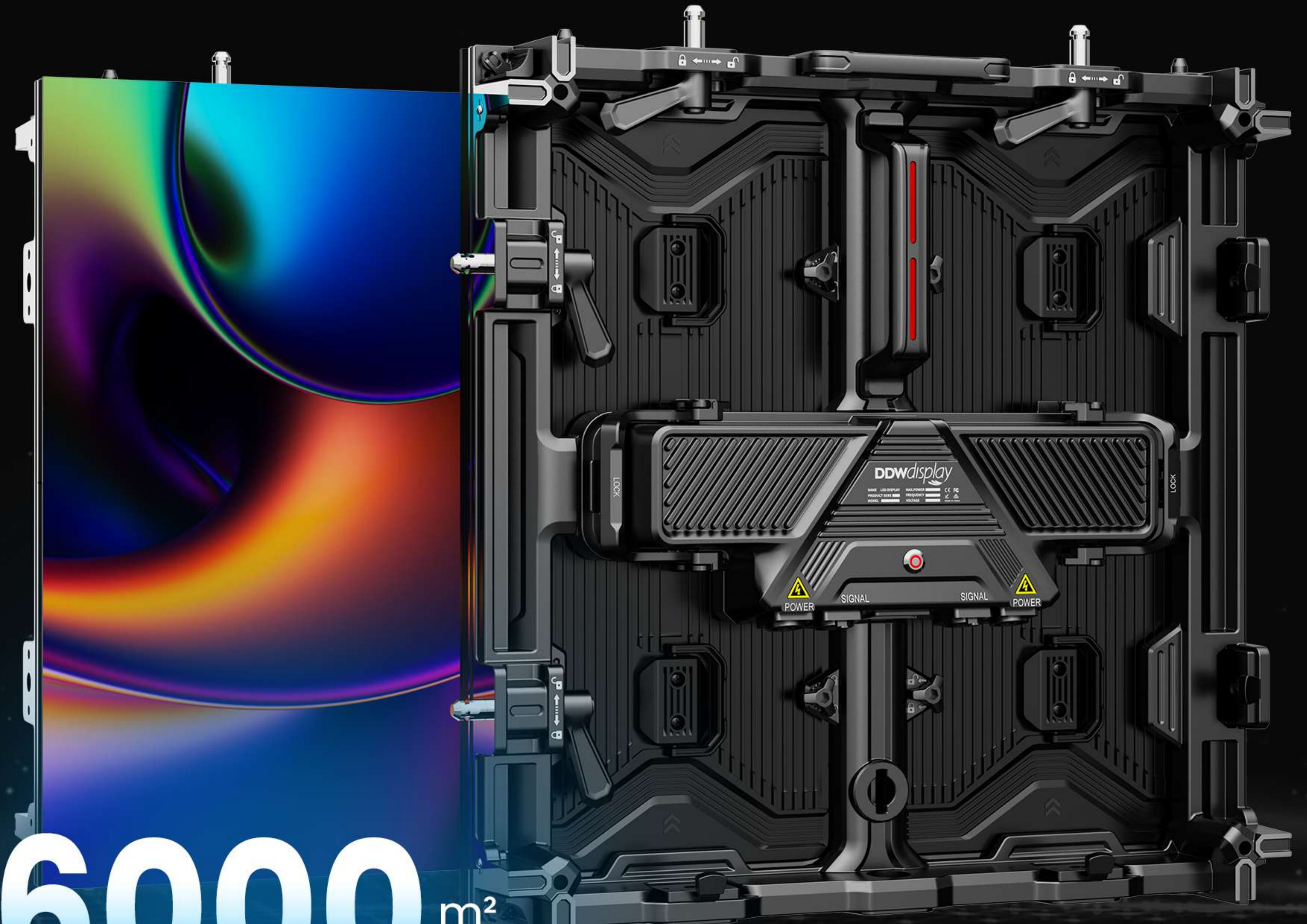

MODULAR DESIGN

All accessories are more standardized, with more stable performance and easier maintenance.

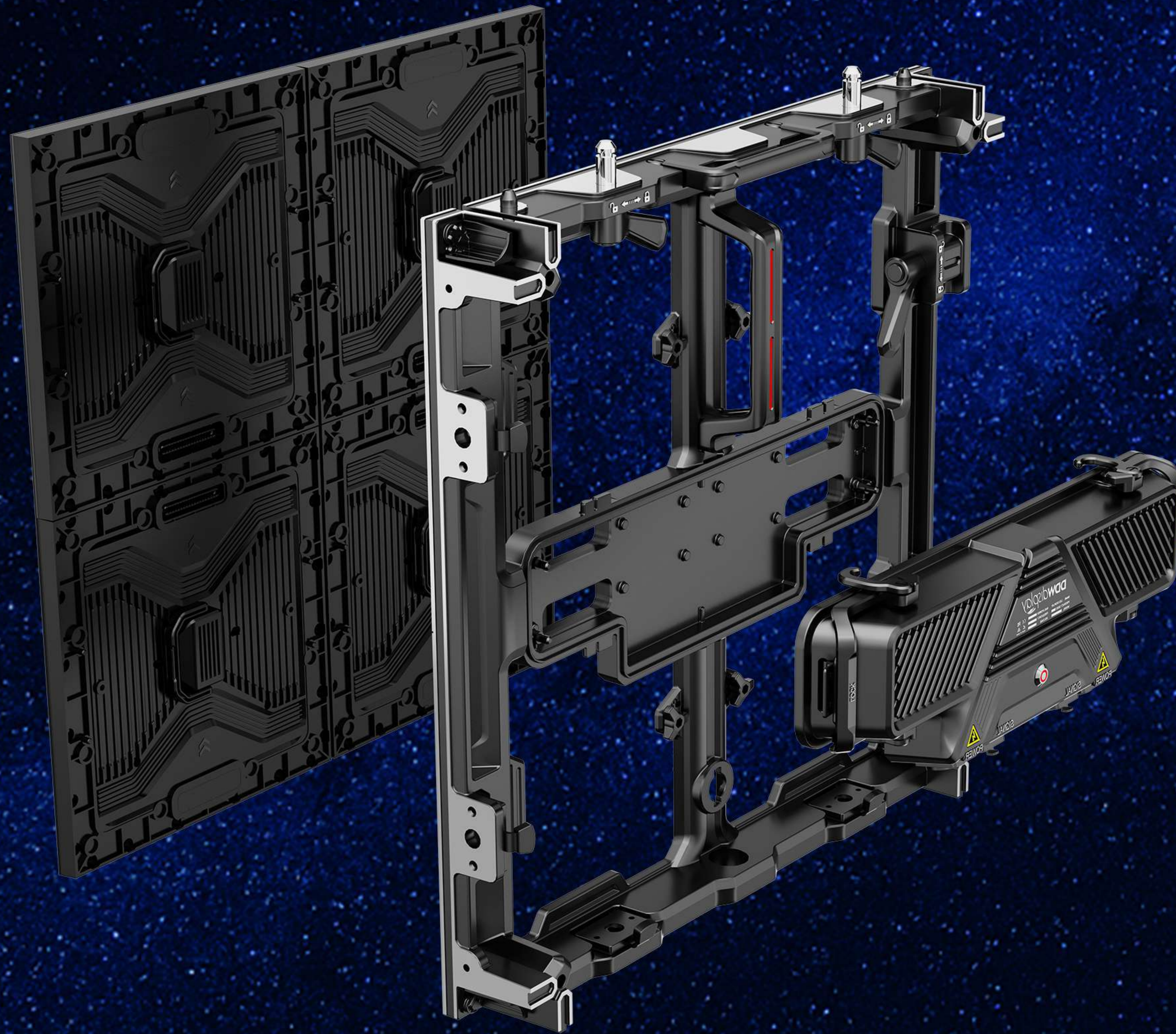

Powerbox lock



Independent power box

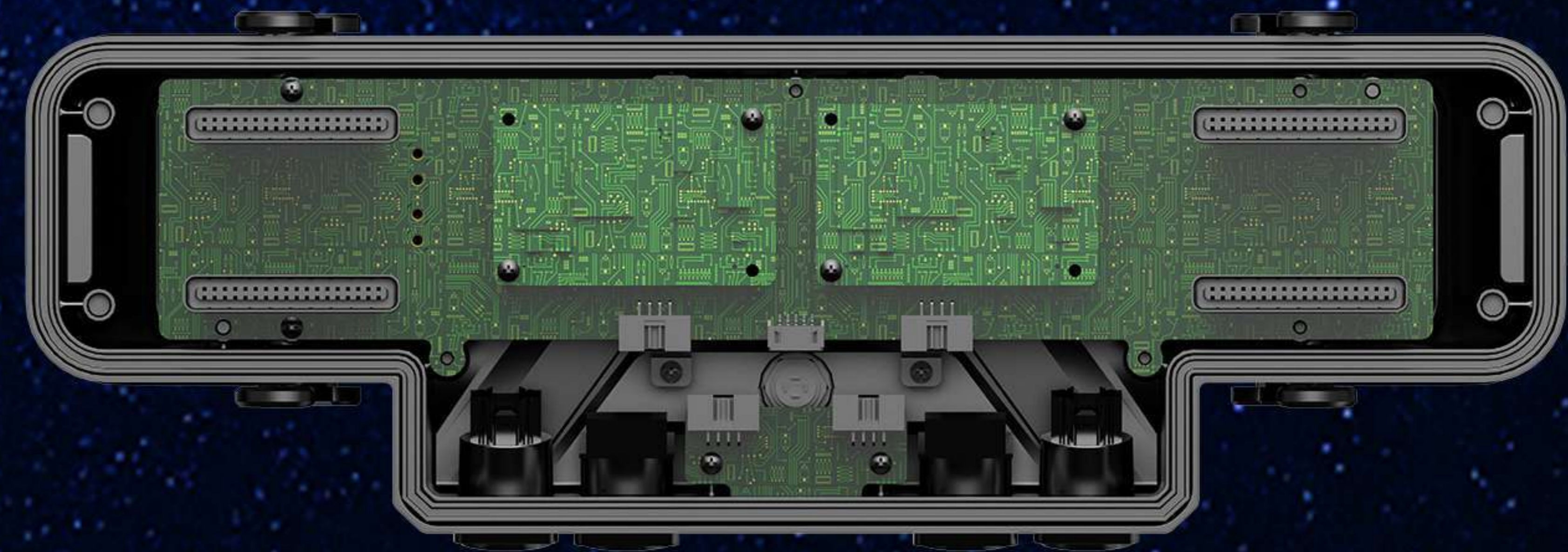

IP65 WATERPROOF

IP65 waterproof, corrosion-resistant, dust-proof, high temperature resistant.

IP65

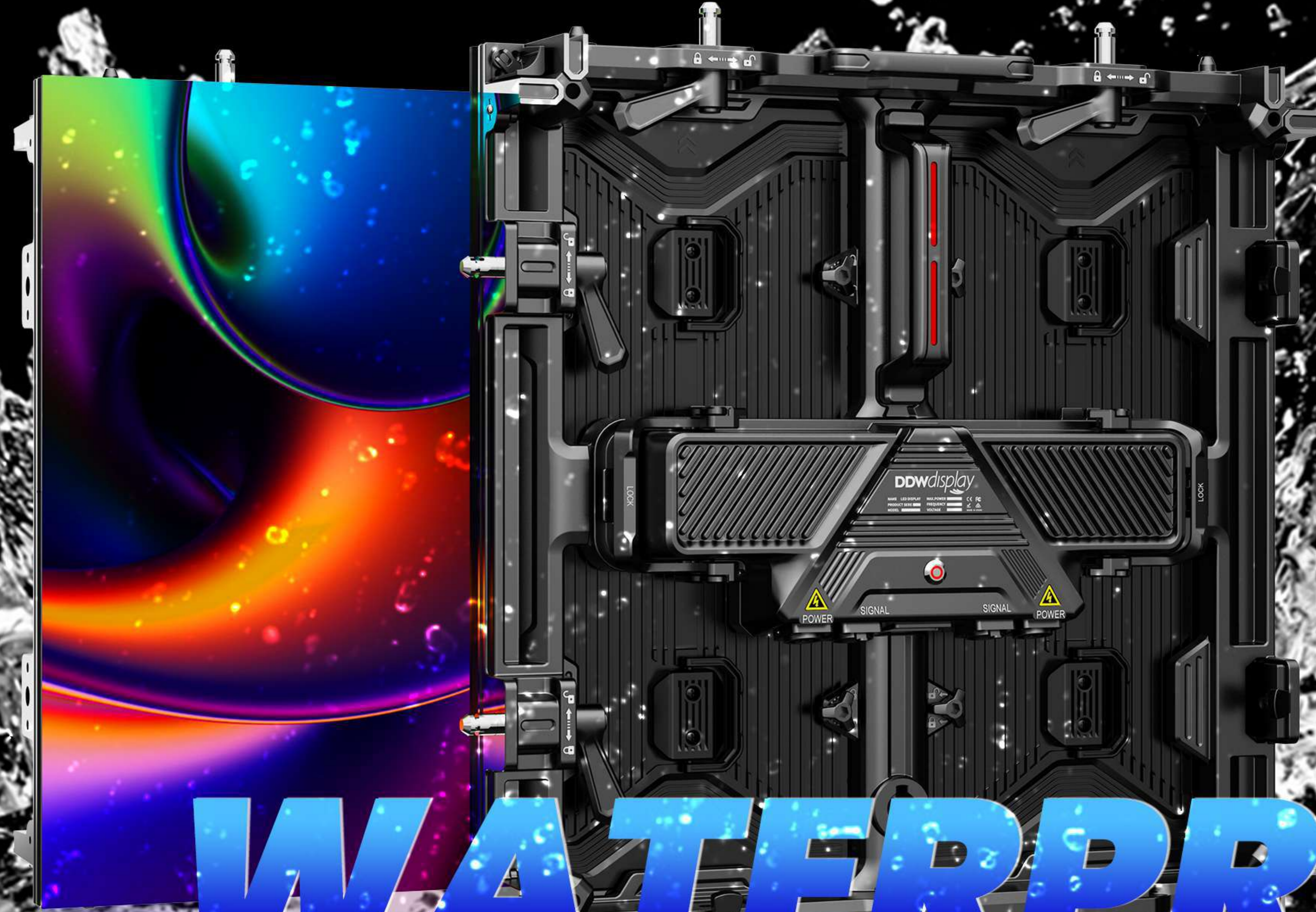

WATERPROOF

90 ° SPLICING INSTALLATION

Customizable 45° beveled cabinet, two cabinets can be directly assembled at a 90 degree angle, right angle is so easy.

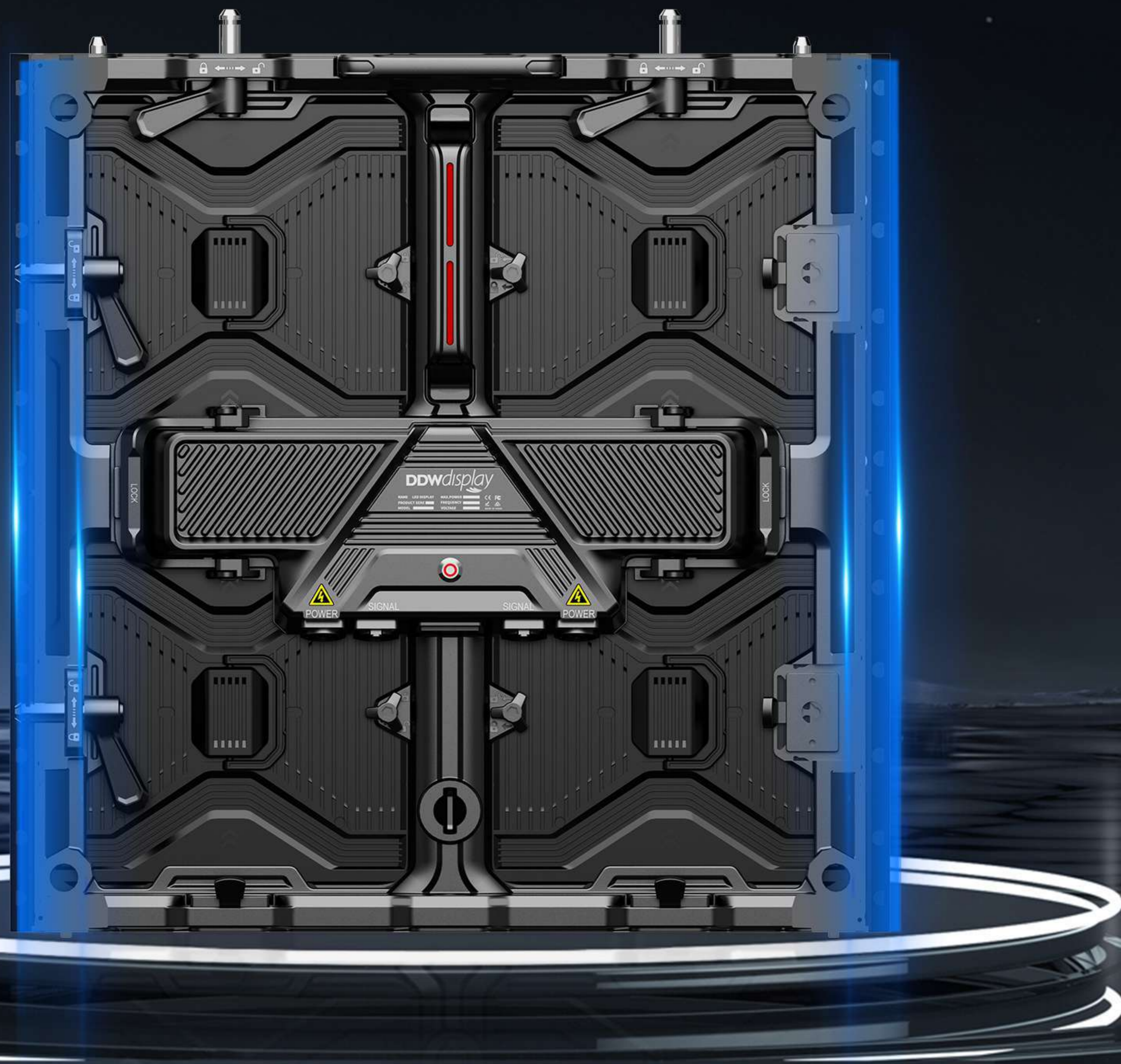

CORNER PROTECTION DESIGN

Rental LED display is designed with four corner guards to effectively prevent damage to the LED during transportation, installation, operation and disassembly.

Corner Protector



CREATIVE INSTALLATION

Can easily build right angles, arcs, and other creative shapes.

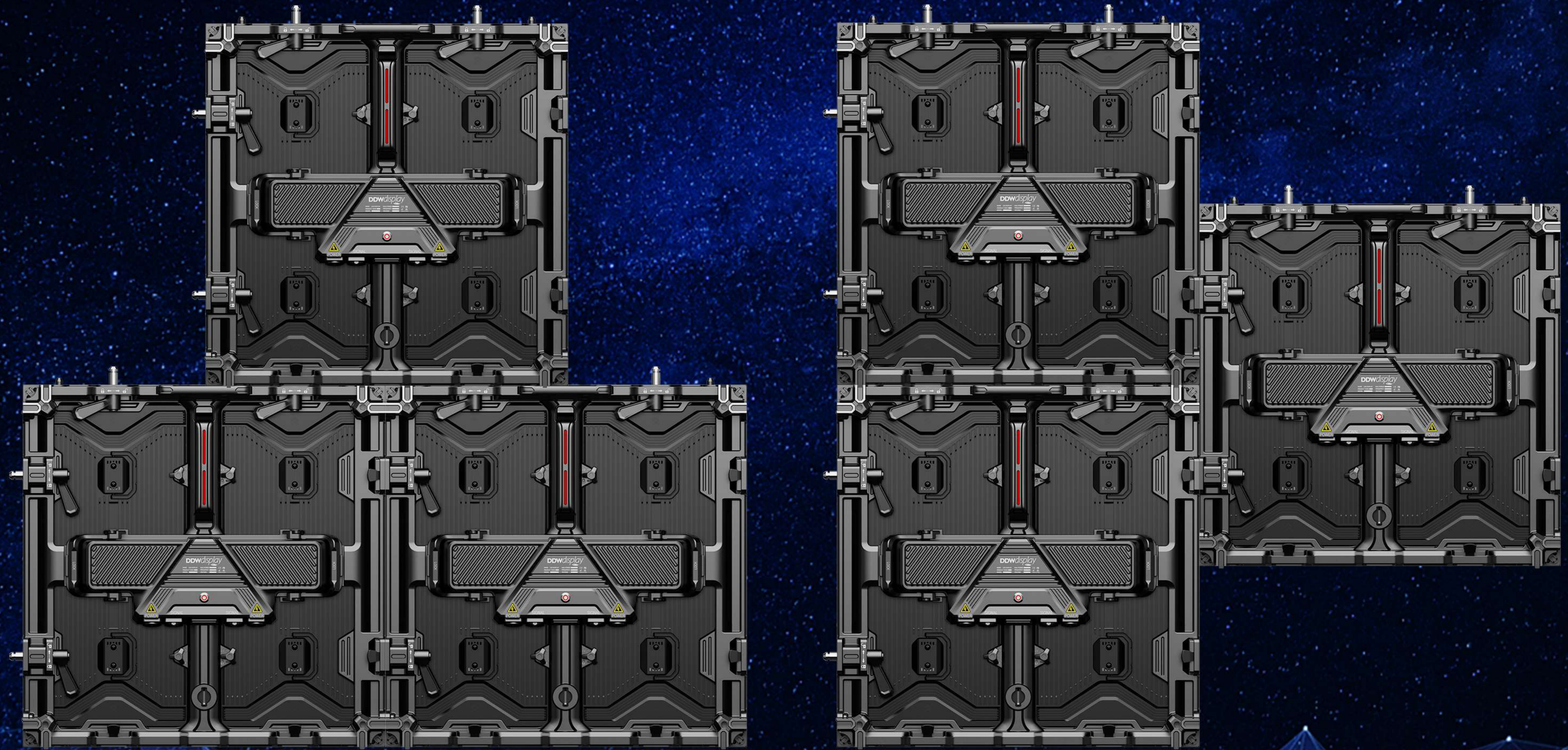

STRONG STABILITY

Dual signal backup, independent power box design for more stable use



FLAT CABINET

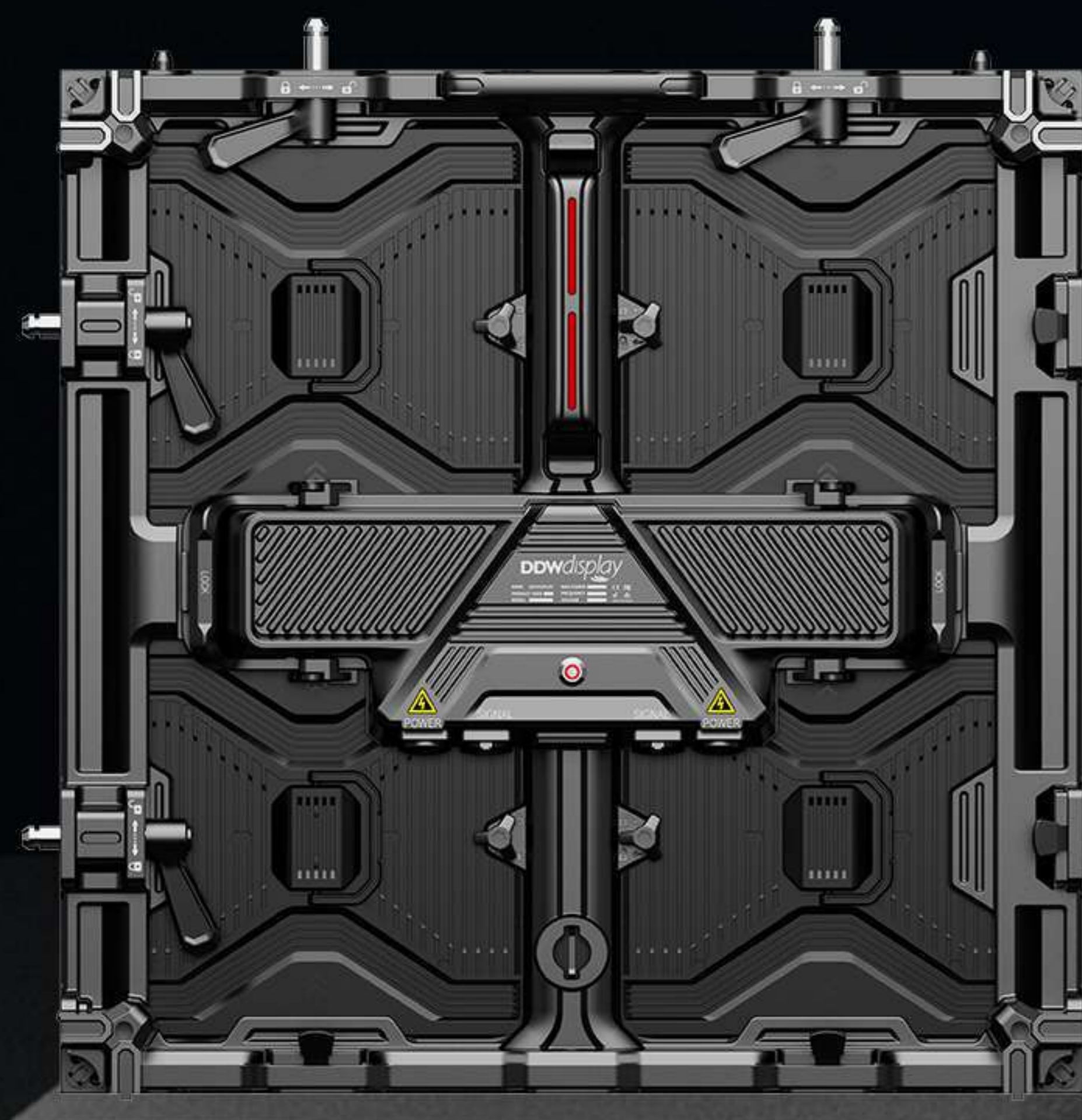

Flat Cabinet

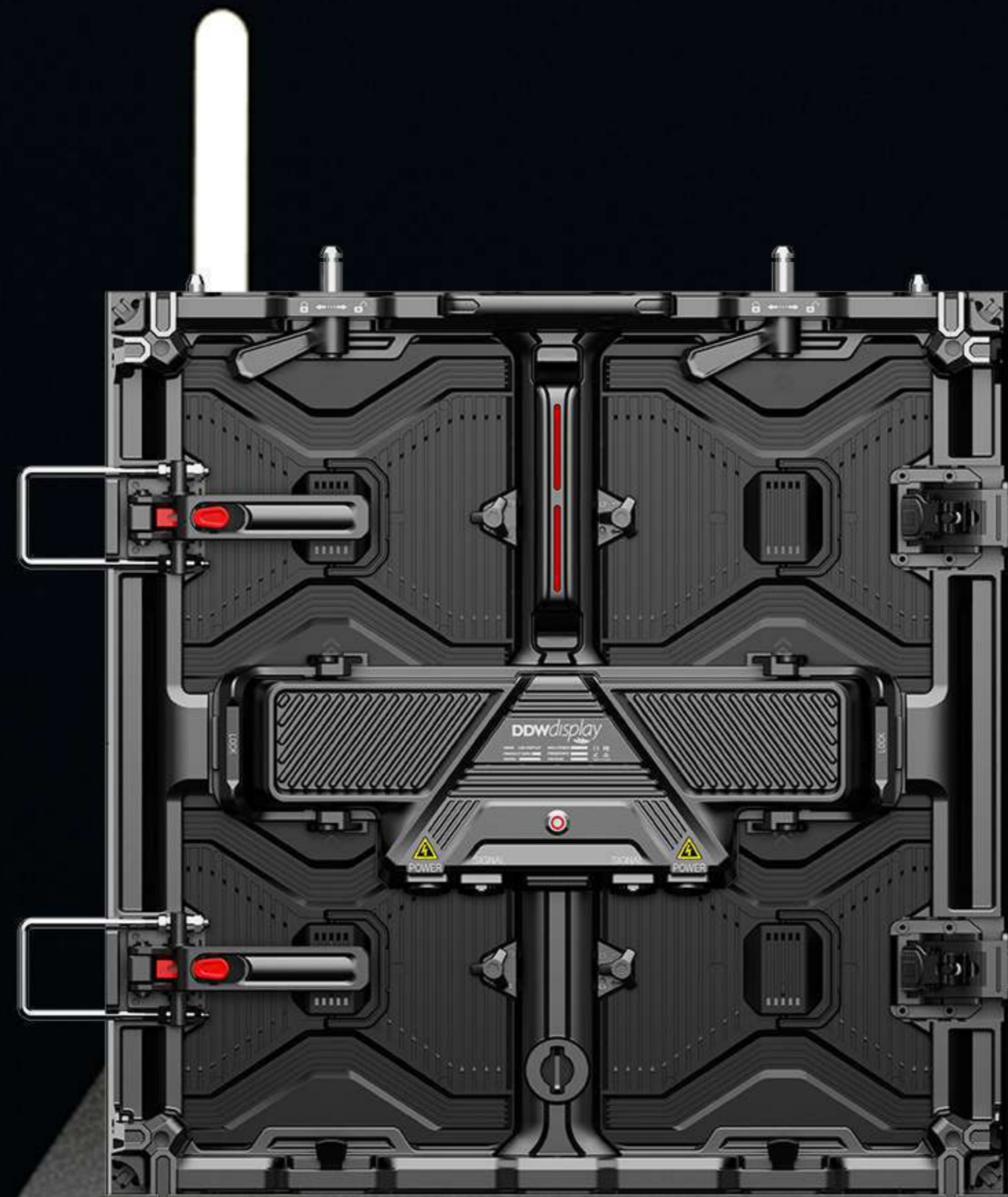

±7.5° curved cabinet

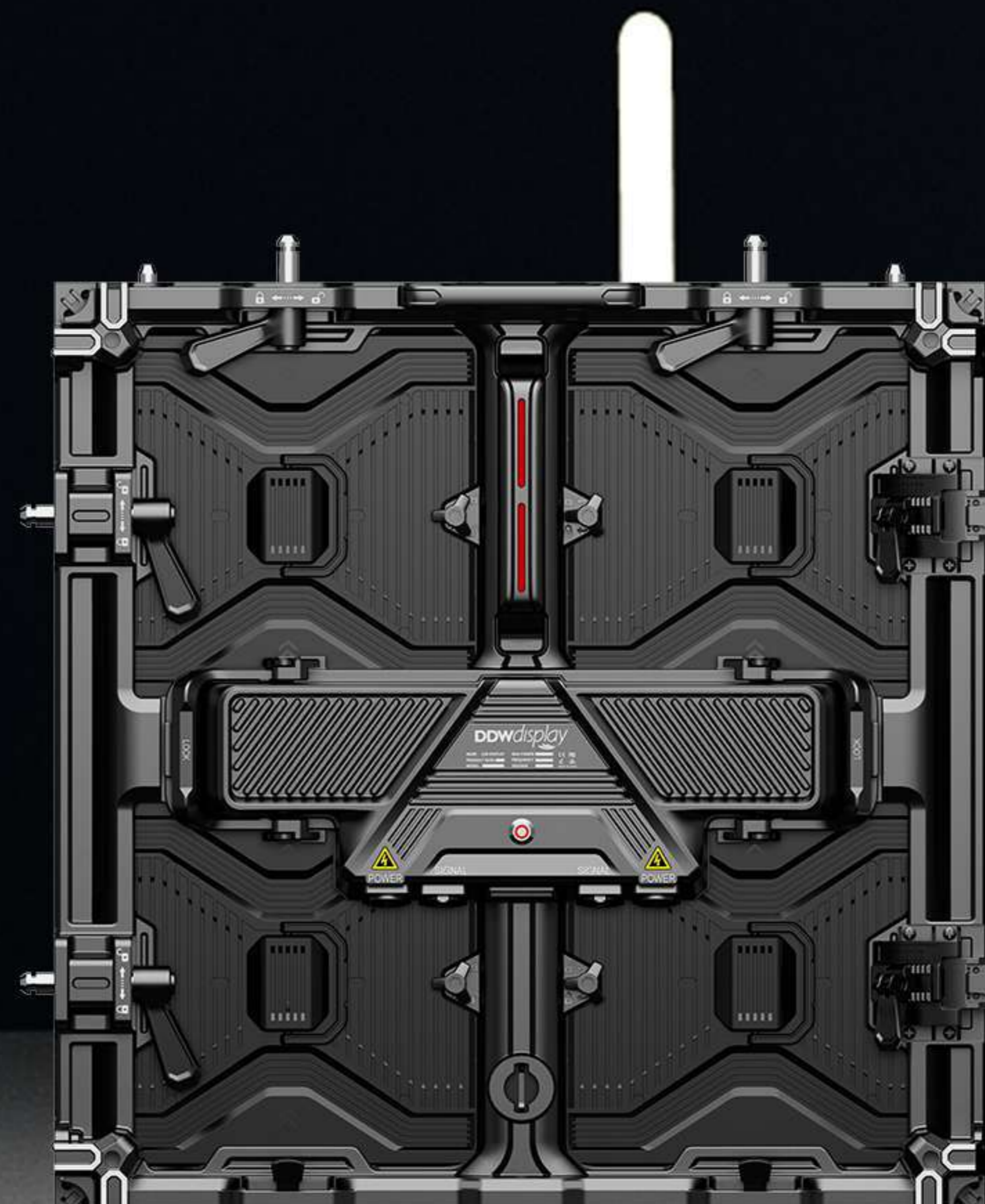

±10° curved cabinet

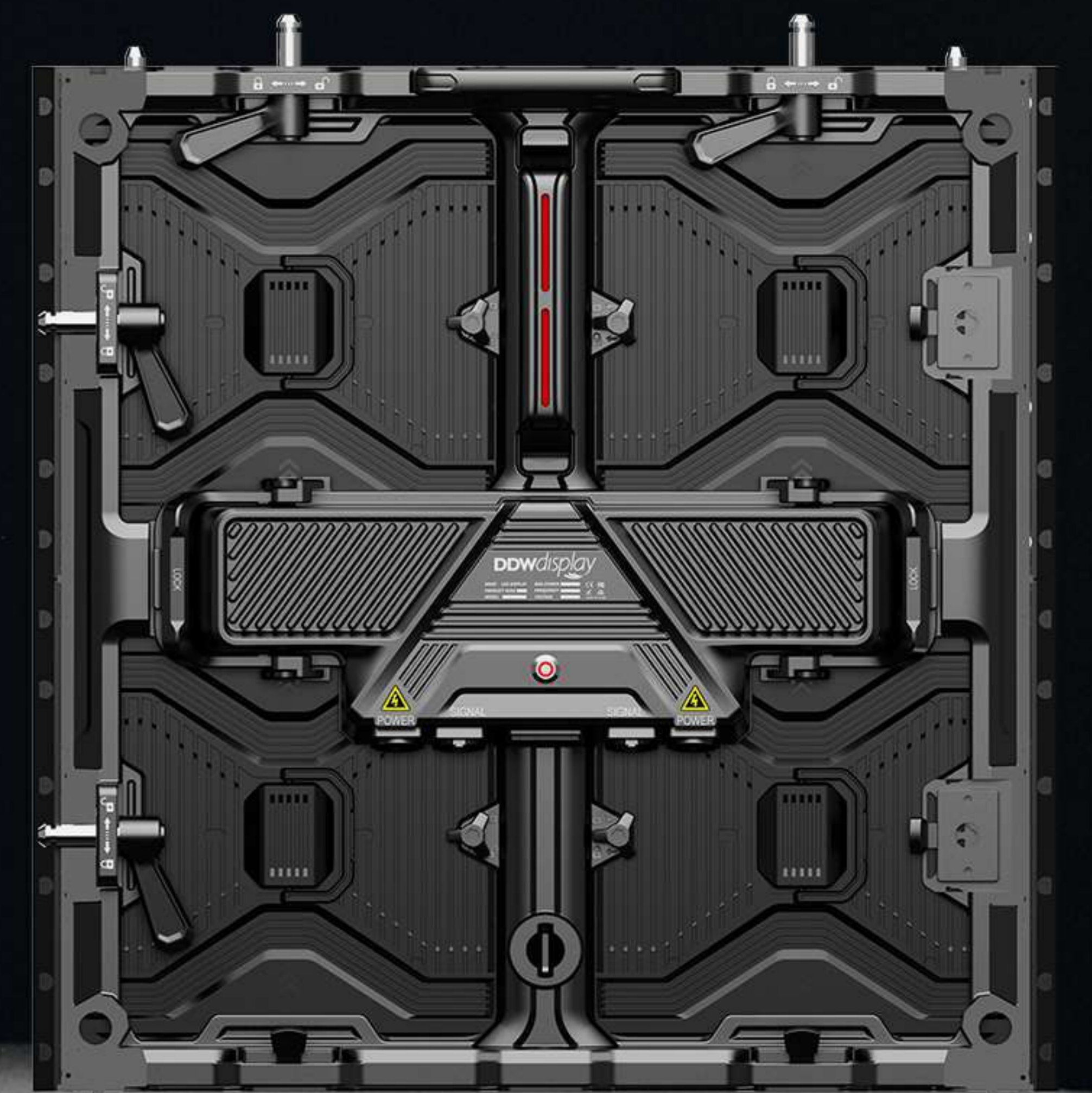

45° beveled cabinet

APPLICATIONS

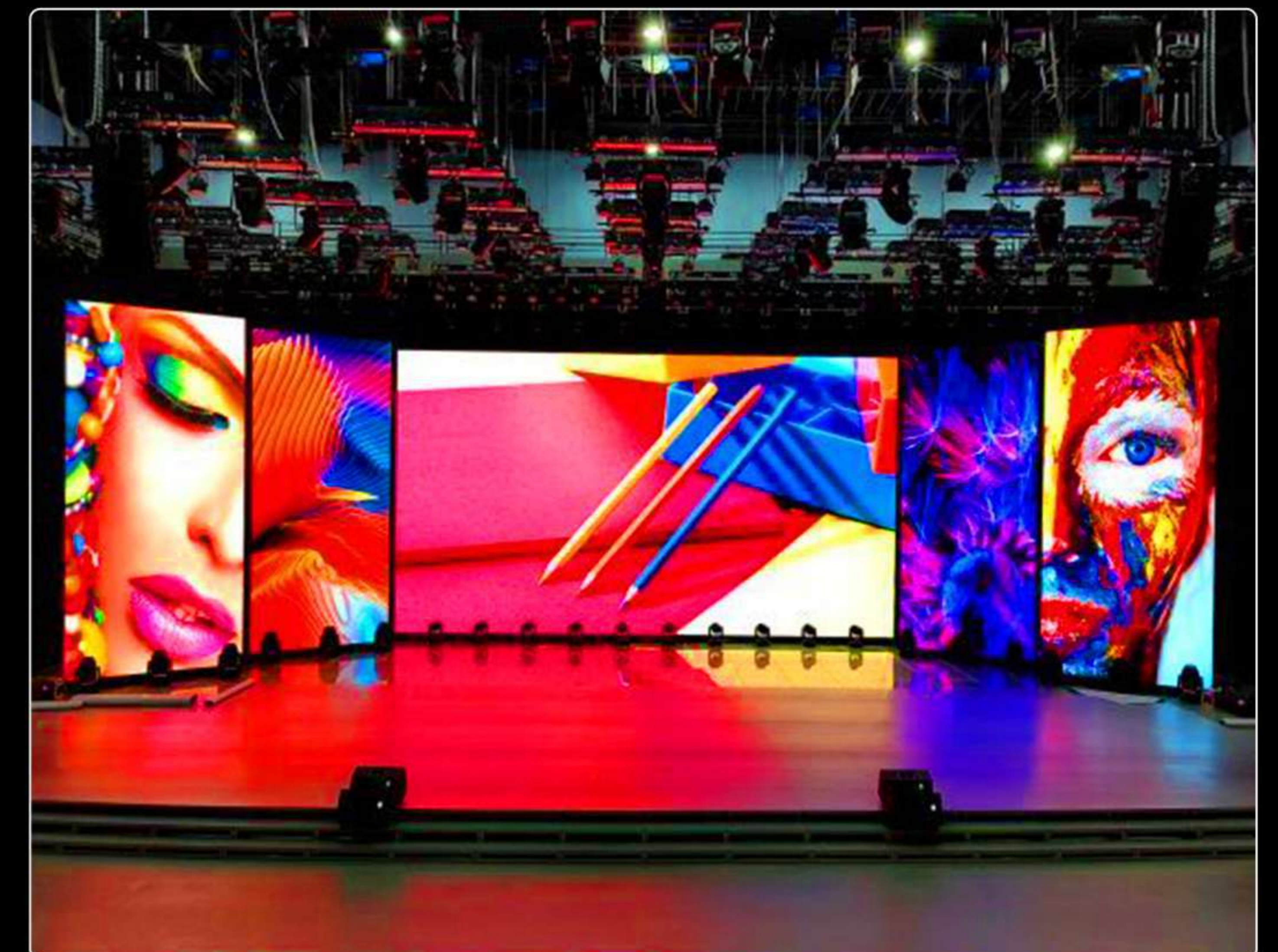
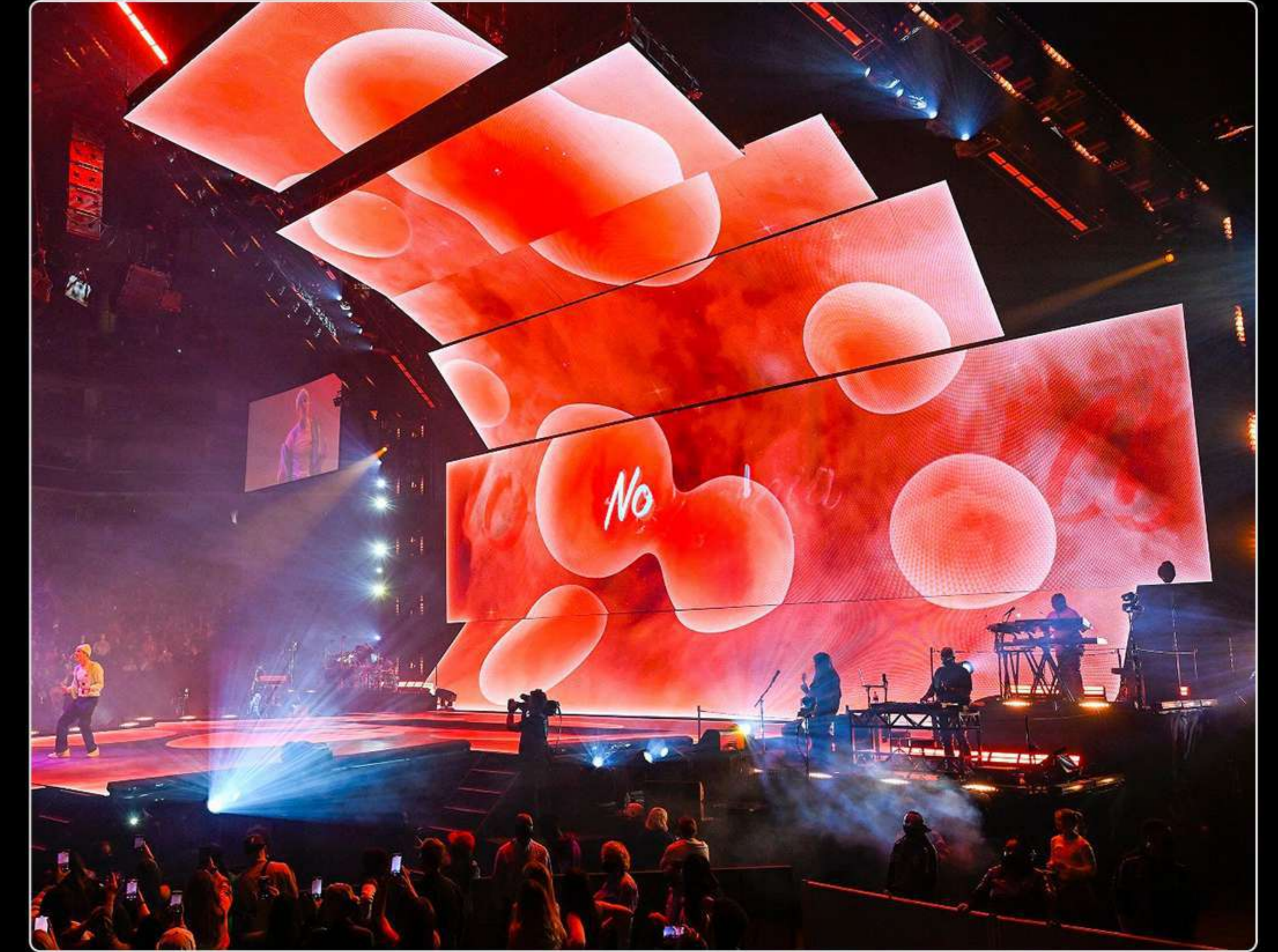

VP & XR

Provide comprehensive virtual film shooting and virtual reality solutions.

 **7680HZ**
High refresh rate

 **10000:1**
High contrast

 **16bit**
High grayscale

 **1/8s**
Scan method



TYPICAL INSTALLATIONS



Stand bracket installation



Hanging installation

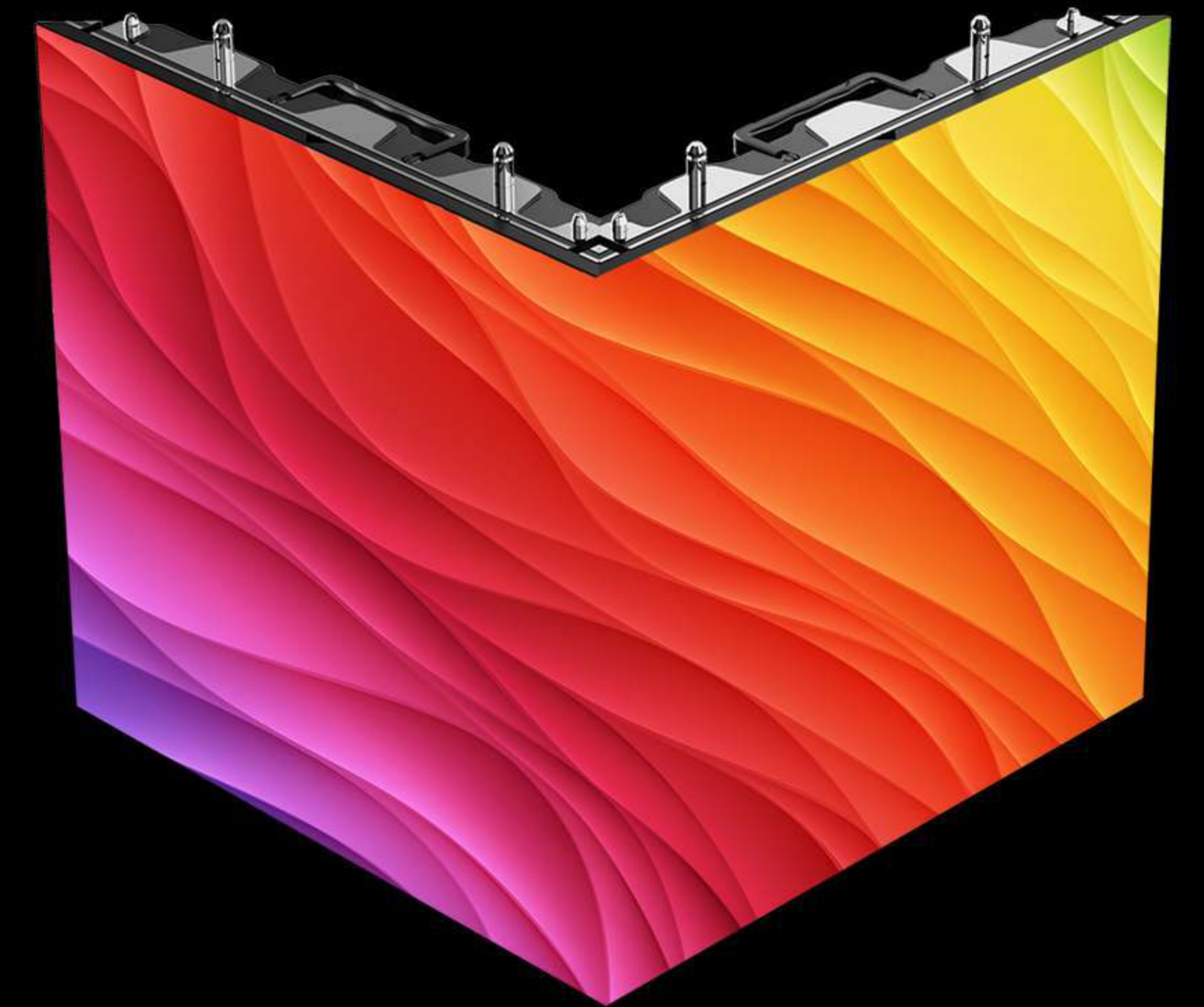

Right angle installation

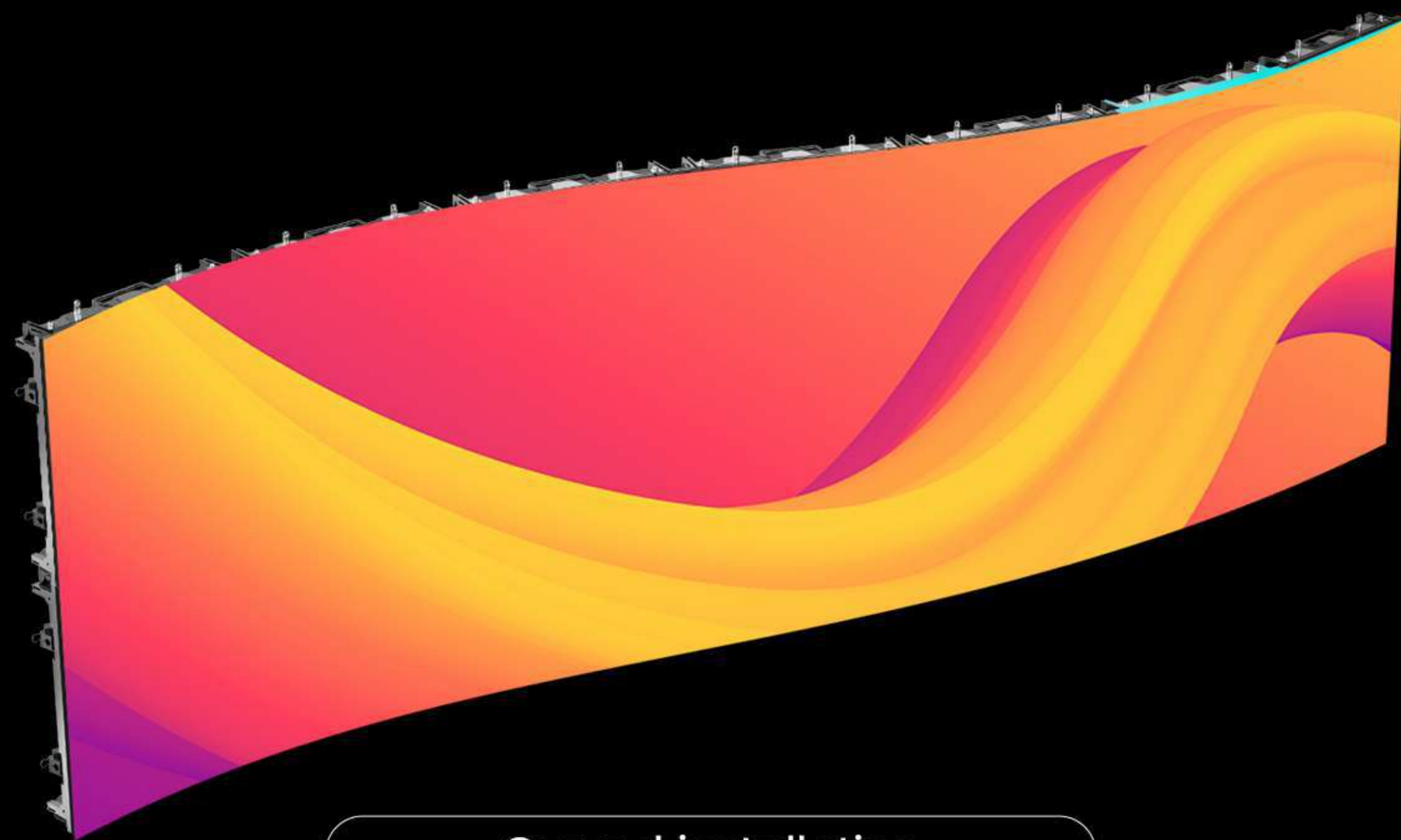

Curved installation

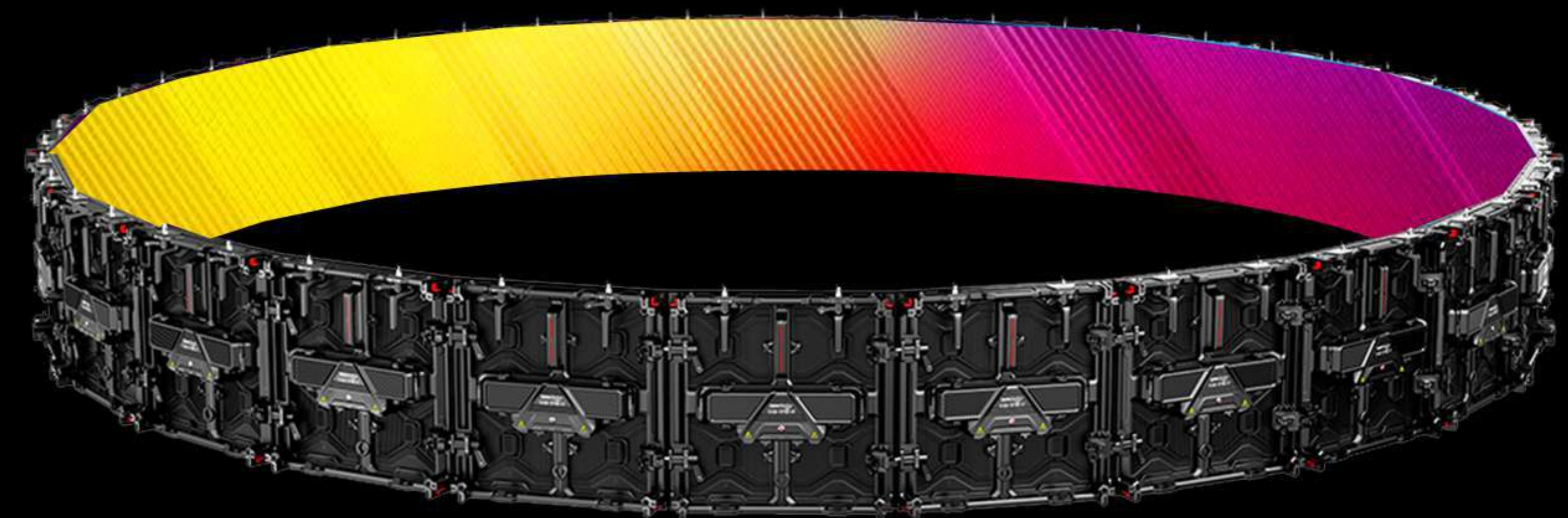

Inner arc/outer arc installation

5 YEARS WARRANTY

Common warranty in LED field is 2 years, ours is 5
Longer warranty periods, better after-sale services
worry-free user experience



OEM&ODM

1000+
Projects

5 days
Fast delivery



Door to door

3D

Installation video



Sample support



CERTIFICATE

The image displays a collection of certification documents for Shenzhen DDW Technology Co., Ltd. The central document is a QMS Certificate of Registration issued by the China General Beijing Certification Center. It certifies the company's Quality Management System (GB/T19001-2016/ISO9001:2015) for the production of LED displays and digital signage. Surrounding this are other certificates: a BCTC Test Report for LED video walls, an IEC CB Test Certificate, a TÜV PS E certificate, a RoHS Certificate of Compliance, and a CE Certificate of Conformity. The documents are set against a background of a starry night sky.



QMS CERTIFICATE OF REGISTRATION
 Registration No.: 12824Q21369R0S

This is to certify that the Quality Management System of
SHENZHEN DDW TECHNOLOGY CO.,LTD
 Unified social credit code:91440300055133476F
 201, Building 8, Yilisheng Industrial Park, No. 602 Fengtang Avenue, Tangwei Community,
 Fuhai Street, Bao'an District, Shenzhen City, Guangdong Province

Has been audited to conform to the following Quality Management
 System Standard:
GB/T19001-2016/ISO9001:2015
 For the whole process of
**Production of electronic products (LED DISPLAY, LCD VIDEO WALL,
 DIGITAL SIGNAGE) (export only)**

DATE OF ISSUE: 10-10-2024 DATE OF SUPERVISION : 10-10-2024 VALID UNTIL: 10-09-2027

Certified organizations within the validity period of the certificate surveillance audit at least once a year
 This certificate is valid until 09-27-2025
 The certificate information is available in the certification and accreditation administration of
 the P.R.C.'s official website: www.cnca.gov.cn





No.21, No.4 Yard, Yuetambeliaojie Street,
 Xicheng District, Beijing
 010-68017408



TEST REPORT

Report No.: BCTC2207738761SN1

Applicant: SHENZHEN DDW TECHNOLOGY CO., LTD

Product Name: LED VIDEO WALL

Product Type: DDW-LW550DUNTMA4

Tested Date: 2024-01-22 to 2025-02-24

Issued Date: 2025-02-24



Shenzhen BCTC Testing Co., Ltd.



Certificate of Compliance

Certificate No.: BKC160001297

Applicant: Shenzhen DDW Technology Co.,Ltd
 3/F, No.5,Intelligent Creation Park, Yabao, Shajing Street,
 Baoan District, Shenzhen,China 518104

Manufacturer: Shenzhen DDW Technology Co.,Ltd
 3/F, No.5,Intelligent Creation Park, Yabao, Shajing Street,
 Baoan District, Shenzhen,China 518104

Product: LED full color display

Test Standard: IEC62321-1:2013

The EUT described above has been consolidated by us and found in Compliance
 with the council RoHS,directive-2011/65/EU.It is possible to use CE marking to
 demonstrate the compliance with this RoHS Directive. It is only valid in connection
 with the test report number: BKC160001297.



Shenzhen BKC Testing Co., Ltd.
 6/F, Building 3, Zhoushang Industrial Park, Nanwan Street, Longgang District,
 Shenzhen, Guangdong, China. Tel:400-059-0700 0755-33170405
 E-mail:beket@bkc-lab.com. Certificate Search: <http://www.bkc-lab.com>



of Conformity





CB TEST CERTIFICATE





Verification of Conformity

Applicant: Shenzhen DDW Technology Co.,Ltd
 502, building 6, Zhengzhong industrial park, X
 Bao'an District, Shenzhen,518103

Manufacturer: Shenzhen DDW Technology Co.,Ltd
 502, building 6, Zhengzhong industrial park, X
 Bao'an District, Shenzhen,518103

Product: Video Wall

Model No.: DDW-LW4601, DDW-LW4602, DDW-LW4603,
 DDW-LW4902, DDW-LW4903, DDW-LW550
 DDW-LW5503, DDW-LW5504, DDW-LW550
 DDW-LW6502, DDW-LW6503

Test acc to: IEC 60950-1:2005+A1:2009 +A2:2013
 IEC 60950-1:2014+A1:2017,IEC 60950-2:4:20



Global Technical Service Co.
 UNIT 04, 7/F, BRIGHT WAY TOWER, NO. 33 MONG KOK ROAD

CONTACT US

SHENZHEN DDW TECHNOLOGY CO.,LTD



0086-755-23229716



0086-134-17558100



www.ddw.net



info@ddw.net



2F Building 8, YiLisheng Industry Park, Fuyong
Baoan District, Shenzhen, 518103